

1
2
3
4
5
6
7
8
9
10
11
12
13
14
15
16
17
18
19
20
21
22
23
24
25
26
27
28
29
30
31

Welcome to our interactive version of **Nitrogen+Syngas** Issue 355

Please use either the buttons on the left or top right of the page to navigate your way around this interactive PDF

IMPORTANT INFORMATION:

Copyright – Issued six times per year, or bi-monthly. All rights reserved. No part of this publication may be reproduced, stored in a retrieval system or transmitted in any form or by any means – electronic, mechanical, photocopying, recording or otherwise – without the prior written permission of the Copyright owner.

Number 355

September | October 2018

nitrogen + syngas

www.nitrogenandsyngas.com

India's 'methanol economy'
Industrial grade ammonium nitrate
Technology integration
Inert catalyst support



CONTENTS

What's in issue 355

COVER FEATURE 1

India's 'methanol economy'

COVER FEATURE 2

Industrial grade ammonium nitrate

COVER FEATURE 3

Technology integration

COVER FEATURE 4

Inert catalyst support

NITROGEN+SYNGAS
ISSUE 355
SEPTEMBER-OCTOBER 2018

BCInsight

Southbank House, Black Prince Road
London SE1 7SJ, England
Tel: +44 (0)20 7793 2567
Fax: +44 (0)20 7793 2577
Web: www.bcinsight.com
www.bcinsightsearch.com

JM

Making a difference to the world around us

With years of operating experience and expertise across the syngas, petrochemical, oil and gas markets, Johnson Matthey continues to invest in technologies that improve processes whilst looking after the environment.

Our gas heated reforming technology is a proven energy efficient solution for syngas generation across multiple applications reducing both CO₂ emissions and raw water consumption, whilst maximising the opportunity to use renewable energy.

Contact us to find out how our technology can benefit your business.

Johnson Matthey
Inspiring science, enhancing life

www.matthey.com



Cover: Karen Massier/iStockPhoto.com



14 Industrial grade AN

Slowing growth for industrial explosives.



27 Catalyst support media

Innovations to improve performance and reliability.

Read this issue online at:
www.nitrogenandsyngas.com

Published by:

BCInsight

nitrogen + syngas

www.nitrogenandsyngas.com

NUMBER 355
SEPTEMBER | OCTOBER 2018

CONTENTS

12 Can India develop a 'methanol economy'?

India is currently engaged in a major policy discussion on greater use of alternative fuels, hoping to emulate the success of China and Brazil in substituting oil imports with domestically produced alternative fuels. Can coal-based methanol be a success there?

14 The market for industrial grade AN

Industrial grade ammonium nitrate (IGAN) is the key component of industrial explosives around the world. As such it forms a distinct market segment of the AN industry separate from fertilizer uses, and occupies roughly 22% of all AN demand.

16 Technology integration adding value

Driven by economic cycles, market developments, increasing investment cost and more stringent environmental requirements, ammonia, urea and methanol producers are looking for integrated solutions to provide reliable, cost effective and sustainable production technologies for their products.

27 Inert catalyst support and hold-down media

Materials science continues to develop and choosing the correct media for syngas applications can create significant value for a customer. The latest market leading developments in catalyst support and hold-down media provide innovative solutions to improve the performance, reliability and availability of syngas plants.

REGULARS

3 Editorial

Feeding the world

4 Price Trends

5 Market Outlook

6 Nitrogen Industry News

8 Syngas News

10 People/Calendar

11 Plant Manager+

Problem No. 50: Low vacuum pressure in the second-stage evaporator

CONTENTS

What's in issue 355

COVER FEATURE 1

India's 'methanol economy'

COVER FEATURE 2

Industrial grade ammonium nitrate

COVER FEATURE 3

Technology integration

COVER FEATURE 4

Inert catalyst support

NITROGEN+SYNGAS
ISSUE 355
SEPTEMBER-OCTOBER 2018

BCInsight

Southbank House, Black Prince Road
London SE1 7SJ, England

Tel: +44 (0)20 7793 2567

Fax: +44 (0)20 7793 2577

Web: www.bcinsight.com
www.bcinsightsearch.com

Feeding the world

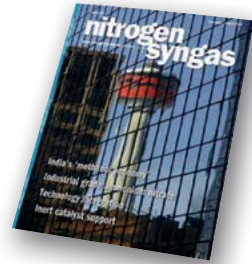

October 13th this year will be the third Global Fertilizer Day. Initiated in 2016 by Fertilizers Europe, the day has attracted the support of fertilizer associations like The Fertilizer Institute in the US, the International Fertilizer Society and the International Fertilizer Industry Association, as well as companies around the world, including OCI Nitrogen and EuroChem.

The date was originally set to mark the anniversary of the discovery of the Haber Process for producing ammonia – in fact October 13th was the day on which Fritz Haber first filed his patent for the process, back in 1908. That means that this year marks the 110th anniversary of that event, which was to have such world-changing ramifications. This year also marked the 100th anniversary of the award of Haber's Nobel Prize for Chemistry, in 1918, which he was awarded for his discovery of the process. It is appropriate that nitrogen gets the honour of setting the date for Global Fertilizer Day, as more than half of all fertilizer nutrient applied around the world is nitrogen, and according to the UN Food and Agriculture Organisation, about 50% of that nitrogen has passed through a Haber-Bosch reaction rather than coming from manures or other natural sources. Haber's discovery also has paved the way for a syngas-based chemical industry which remains dominated by ammonia for fertilizer uses, but which, as articles in this issue remind us, also now subsumes methanol, potentially a clean-burning fuel to replace consumption of diesel and heavy fuel oils, and ammonia for other uses such as explosives, widely used in mining the essential minerals like copper and iron that the world runs on.

While the over-application of mineral fertilizer, or its use at the wrong time of year can cause leaching into water courses and consequent algal blooms, these are issues that can and are being solved via education of farmers in nutrient use efficiency. In the meantime, it remains indisputable that fertilizers keep half of the world's population alive, and have helped lift millions out of poverty and famine, allowing our world to grow and develop as we know it today, and it is these benefits that Global Fertilizer Day aims to celebrate.

But it is also perhaps an opportune moment to look ahead at where the nitrogen fertilizer industry may be going over the next 100 or 110 years. The past few decades have seen a race to keep pace with rapidly increasing populations in Asia, especially China and India. However, rates of population growth are slowing in these countries, especially China, and may reach a maximum by 2050. Conversely, Africa's population is projected to double by that time. Nitrogen fertilizer demand is set to be capped from 2020 in China, as the government attempts to tackle over-application and use fertilizer more efficiently. The challenge of the next 30 years will be to feed Africa, where fertilizer application rates currently remain very low.

Other long-term trends include increasing urbanisation, and the consequent change to a more protein-rich diet in developing countries. The European Soil Data Centre (ESDAC) has calculated that because of this, in spite of falling rates of population growth, overall the world may need 70% more food by 2050 compared to 2010. Barring some major breakthrough in genetic modification of crops, or a widespread switch to a vegetarian diet, this is going to require intensification of agriculture. Even so, projected nutrient use efficiencies mean that the ESDAC projection is that the world will only need an extra 35 million tonnes N per year by 2030 compared to 2015, representing an approximately 1.1% average annual growth rate – much lower than the kind of growth rates that have been seen over the past 50 years.

Still, as the world's population moves towards 9 billion, and Africa's towards 2 billion, fertilizer will continue to play its key role in feeding the world. ■

Richard Hands, Editor



Total Zero Pollution technologies.
This is what we do to help preserve the planet Earth.
Euromel® Melamine is the only melamine technology that does not generate (therefore does not release into the environment) solid or liquid effluents.



www.euromel.com

CONTENTS

What's in issue 355

COVER FEATURE 1

India's 'methanol economy'

COVER FEATURE 2

Industrial grade ammonium nitrate

COVER FEATURE 3

Technology integration

COVER FEATURE 4

Inert catalyst support

NITROGEN+SYNGAS
ISSUE 355
SEPTEMBER-OCTOBER 2018

BCInsight

Southbank House, Black Prince Road
London SE1 7SJ, England
Tel: +44 (0)20 7793 2567
Fax: +44 (0)20 7793 2577
Web: www.bcinsight.com
www.bcinsightsearch.com

Price trends



MARKET INSIGHT

Alistair Wallace, Head of Fertilizer Research, Integer Research, assesses price trends and the market outlook for nitrogen.

NITROGEN

Urea prices surged from \$220/t f.o.b. Egypt in June to over \$300/t by early August, with Chinese export availability still capped at around 100-150,000 tonnes per month despite China's domestic season coming to an end in mid-July. Iran's opportunities to export were severely curtailed by the Trump administration's new round of sanctions, and its f.o.b. spot price was forced to severely discount other Middle Eastern exporters. At the time of writing, f.o.b. Arab Gulf spot tons were being offered at just under \$330/t, while Iranian spot sales were pricing at just \$235/t to those brave enough to ignore US sanctions. Urea markets remained bullish throughout August, even with the downwards pressure put on prices as traders closed out long positions and triggered a brief run on prices that squeezed southern Atlantic markets. Following that, a significant portion of the world's export availability was paused while the Middle East/North Africa region paused for the Eid holiday.

Chinese urea producers' operating rates are almost certainly declining now that the domestic season has come to an end. We had expected the close of the Chinese application season to allow an

increase in Chinese export availability, as producers took the opportunity to sell into the international market. However, monthly export volumes (at least for July) look to be flat at around 100,000 tonnes, and domestic pricing is holding up beyond our expectations at \$290-300/t, a similar level to the prices offered f.o.b. Arab Gulf. With pricing at parity to the Arab Gulf we should not expect to see any serious export availability beyond the most efficient producers (China Coal and China Blue Chemical). We know that domestic demand is falling, and as prices have not shifted down to allow exports, it seems very likely that production must also be declining. And while we do not have access to any production data for July or August, rumours are that operating rates have now fallen to below 60% of installed capacity.

In Ukraine, urea production is back online at Dneprozot, Cherkassy and Severodonetsk, but this will be focused solely on the domestic market. Prices in the Ukrainian interior are commanding a premium of about \$50-60/t over Black Sea export prices, given the ban on Russian imports. And with this pricing level, reasonable margins on domestic Ukrainian business should be possible. However, the export market, at least for now, looks out of reach for Ukrainian exporters

like OPZ's large export-orientated plant at Odessa (currently idle). However, as with other price rallies over the last 18 months, rumours are already circulating that OPZ is preparing to operate in September should prices remain firm.

While the idiom that a rising tide lifts all boats may no longer apply to the global economy, it still looks to be a firm rule in the nitrogen market, where rising urea prices have provided upwards momentum to ammonia prices. European gas prices are heading above \$8.00/MMBtu which will force Ukrainian prices to \$10.00/MMBtu, meaning we are unlikely to see a resumption of Ukrainian ammonia exports. Black Sea ammonia availability is therefore a little constrained and urea upgrading margins on business west of Suez are relatively low at ~\$75/t. East of Suez, upgrading margins f.o.b. Middle East have risen to \$115/t, showing quite how oversupplied ammonia is relative to urea (a higher upgrading margin provides higher returns to urea producers when ammonia is relatively oversupplied.)

European nitrates premiums had fallen to 20% at the time of writing, down from 55% in Q1 2018. They look to have been squeezed by resurgent urea prices and by weak, low season European nitrates demand. Given spot prices for gas in Europe increased to \$8.00/MMBtu in August, producer margins in the EU will be under pressure. If gas prices continue to rise in Europe, expect to see list prices for Q4 deliveries increasing sharply. European pre-buying should also help premiums strengthen as we move through Q4 2018.

All in all, Q3 has been a strong quarter for nitrogen pricing. The rally in the urea market that began in June has had more longevity than most stakeholders had hoped for. Indian demand re-emerged and the severity of the US administration's new Iranian sanctions caused non-Indian Iranian netbacks to collapse as buyers vanished. While coal prices remain buoyant at \$100/t, Chinese export business will be scarce and unless the Chinese administration completely changes its sentiment on pollution, we should not expect this to change. Nitrates premiums will recover over the next few months. However, ammonia is a concern, and the addition of EuroChem's Baltic ammonia project at Kingssepp should also dampen prices by the end of the year.

END OF MONTH SPOT PRICES

natural gas

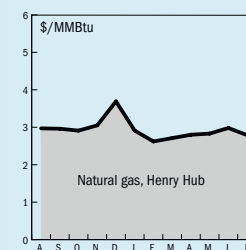

ammonia

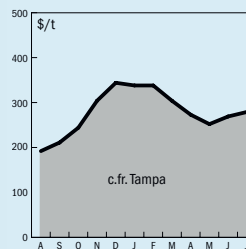

urea

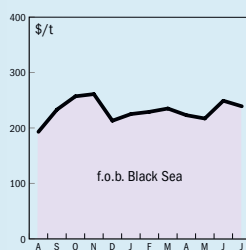

diammonium phosphate

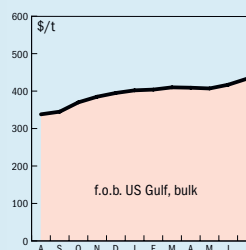

METHANOL

Southern Petrochemicals reference North American methanol price for August was set in late July at \$1.44/gallon (\$479/t), down five cents on the July value. Methanex's non-discounted reference price was two cents higher at \$1.46/gallon, equivalent to \$485/t, also down slightly on July. US spot prices have moved at an average 15% discount to contract rates in recent months.

Global methanol prices have been stable and high for the first half of the year, and Methanex CEO John Floren said in July during the company's 2Q results presentation that it expects them to remain so at least through 3Q 2018, although there could be some volatility later in the year as new supply comes on-stream in the US. This new supply is chiefly coming from Natgasoline's new 1.75 million t/a methanol plant in Beaumont, Texas. The plant – now the largest in the US – began operations in June and is ramping up its output, which is expected to displace US Gulf Coast imports from Trinidad and boost US methanol exports as well. Higher oil prices have been a bullish factor for methanol markets, making fuel use demands for methanol such as methyl t-butyl ether (MTBE), dimethyl ether and direct fuel blending all proportionately more affordable, but new capacity should start to make its impact felt over the next few months.

Methanol prices have come down in Europe from their peak of nearly €400/t in June, declining throughout July but remaining fairly stable in the opening weeks of August. This stability has come in spite of methanol transport across Europe being disrupted by low water levels along the Rhine river system, which has led to displacement of cargoes onto road and rail. Reports suggest that some methanol has ended up in storage rather than being trucked to its destination. At time of writing, however, this had not impacted on methanol spot prices, which remained stable in the region of €348-350/t f.o.b. Rotterdam, and there were no reports of shortages as yet. Prolonged dry weather in Europe and continuing low water levels could see that situation begin to change ahead of 4Q price settlements, however. Meanwhile, seasonal demand into MTBE and biofuels is good, and chemical uses such as formaldehyde are benefitting from continuing good GDP growth figures for the Eurozone. At the same time, stocks in general started the year lower than usual and have not been replenished because of production turnarounds during Q2, and

there are reasons to expect higher methanol prices in Europe over the next couple of months in spite of additional availability from the US.

Outages at Chinese methanol to olefins plants due to both planned and unplanned maintenance have taken the edge of Chinese methanol demand in June, with operating rates below 70%. July saw one plant come back on-stream but another take a turnaround. This is generally a time of slacker seasonal demand in China, and Methanex's Asia-Pacific reference price was cut \$10/t for August to \$480/t. China's 25% tariff on US methanol was a major talking point for the industry. Chinese domestic spot prices ran up during the first half of July to \$420/t, but then fell back to around \$400-405/t for the rest of the month. However, prices jumped in August to \$445/t on news of the tariff increases, falling back only a little to \$425-430/t by mid-month. The US exports only limited volumes of methanol to China – less than 50,000 t/a – and most of its exports actually go to South Korea. Both China and the US are net methanol importers, and could easily switch to imports from Trinidad, New Zealand and the Middle East. A more serious potential effect on the market could come from US sanctions on Iran, especially if European countries follow suit. However, tariffs on polyethylene and polypropylene may have more of a knock-on effect on the Chinese methanol industry if they lead to domestic methanol to olefins capacity having to run at higher rates to make up for shortages.

Meanwhile, Southeast Asia faced a shortage of methanol due to turnarounds. The 1.7 million t/a Petronas plant takes a 48 day turnaround from mid-August, while the Brunei Methanol Company has faced operating issues at its 850,000 t/a plant. A methanol tanker bound for Southeast Asia was also stranded in an Indian port by technical issues, and turnarounds at Middle East methanol plants have also affected availability, leading to a short term problem for customers such as biodiesel producers – demand for methanol for biodiesel production in the region is running high. There was a short-term price spike which led to an opportunity for Chinese suppliers to send more product into the region. Southeast Asian methanol prices are normally about \$30/t above Chinese rates – around the same as the freight rate from South China to Singapore. However, the gap widened in July and reportedly 40,000 tonnes of Chinese methanol made its way south.

Table 1: Price indications

Cash equivalent	mid-July	mid-May	mid-Mar	mid-Jan
Ammonia (\$/t)				
f.o.b. Black Sea	244-250	280	250-255	310-325
f.o.b. Caribbean	270	220	270	320
f.o.b. Arab Gulf	260-280	263	265-275	330-340
c.fr N.W. Europe	300-310	280-305	290-300	350-385
Urea (\$/t)				
f.o.b. bulk Black Sea	245-260	215-220	232-238	215-225
f.o.b. bulk Arab Gulf*	270-280	215-223	253-263	242-250
f.o.b. NOLA barge (metric tonnes)	220-242	219-224	264-280	256-268
f.o.b. bagged China	270-290	257-262	305-315	285-295
DAP (\$/t)				
f.o.b. bulk US Gulf	427-430	408-410	413-415	395
UAN (€/tonne)				
f.o.t. ex-tank Rouen, 30%N	n.a.	153-158	158-161	160-165

Notes: n.a. price not available at time of going to press
n.m. no market * high-end granular

CONTENTS

What's in issue 355

COVER FEATURE 1

India's 'methanol economy'

COVER FEATURE 2

Industrial grade ammonium nitrate

COVER FEATURE 3

Technology integration

COVER FEATURE 4

Inert catalyst support

NITROGEN+SYNGAS
ISSUE 355
SEPTEMBER-OCTOBER 2018

BCInsight

Southbank House, Black Prince Road
London SE1 7SJ, England
Tel: +44 (0)20 7793 2567
Fax: +44 (0)20 7793 2577
Web: www.bcinsight.com
www.bcinsightsearch.com

Historical price trends \$/tonne

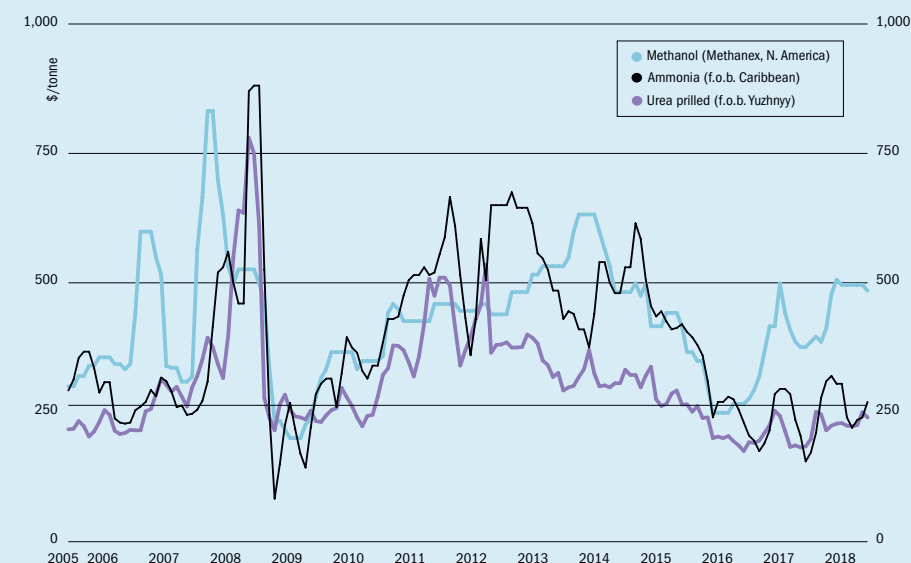

Source: BCInsight

AMMONIA

- Ammonia markets have tightened over the past six weeks, increasing in price by almost \$60/t since mid-June.
- Much of this recovery has been driven by improved sentiment in the urea markets, as well as rising production costs in Europe.
- Production outages are still playing a key role in price formation, and there is currently no export availability from Ukrainian producers, while Yara's Pilbara plant in Australia is still down for maintenance and two of Nutrien's (formerly Agrium's) merchant ammonia lines in Trinidad are closed for planned maintenance.
- Increasing urea prices mean that we are expecting ammonia prices to continue to strengthen despite the restarting of the idled Caribbean and Australian plants next month.
- Supply west of Suez looks more scarce than that east of Suez, where price increases have been limited to just \$30/t. The restart of Yara's Pilbara plant will likely limit price increase until

the re-emergence of Indian ammonia demand in Q4.

- Energy prices are rising in Europe. OPZ in Ukraine is looking to secure gas supplies for September business, however, with European hubs like TTF pricing at above \$8.00/MMBtu it seems unlikely the plant will be able to operate profitably at \$330/t f.o.b. Black Sea.

UREA

- Business with non-Indian import markets is severely limited and spot sales of Iranian urea are currently offered at just \$235/t. For now, Indian business seems possible. However, we have heard anecdotally that payments on the July MMT tender have still not been completed which puts a question mark over future Iranian business.
- Chinese exports do not look like they will increase substantially from 100-150,000t per month, which will limit annual exports below 2.0 million tonnes this year. This should allow prices to rise above \$300/t for a sustained period as demand emerges.

- European, Turkish and Brazilian demand should push prices up next month, before we see US pre-buying kicking off in earnest by mid-October. Despite the completion of the US capacity buildout, significant imports will still be required by the US in Q4 2018 and should cause price to hit an annual high.

METHANOL

- The prospect of an escalating trade war between the US and China has kept the market buoyant. While China imports very little methanol from the US and the US virtually none from China, the effect on oil prices means that the oil-gas price spread has been beneficial for methanol producers. Restrictions on olefins may also lead to more MTO production in China, while fresh sanctions on Iran could affect availability from there.
- New supply is continuing to come to market – Natgasoline in the US in June, more capacity in Iran, and ShchekinoAzot in Russia (500,000 t/a) due in September, which should have a bearish impact on the market by the end of the year.

YOUR GLOBAL PARTNER FOR CATALYTIC GAUZES

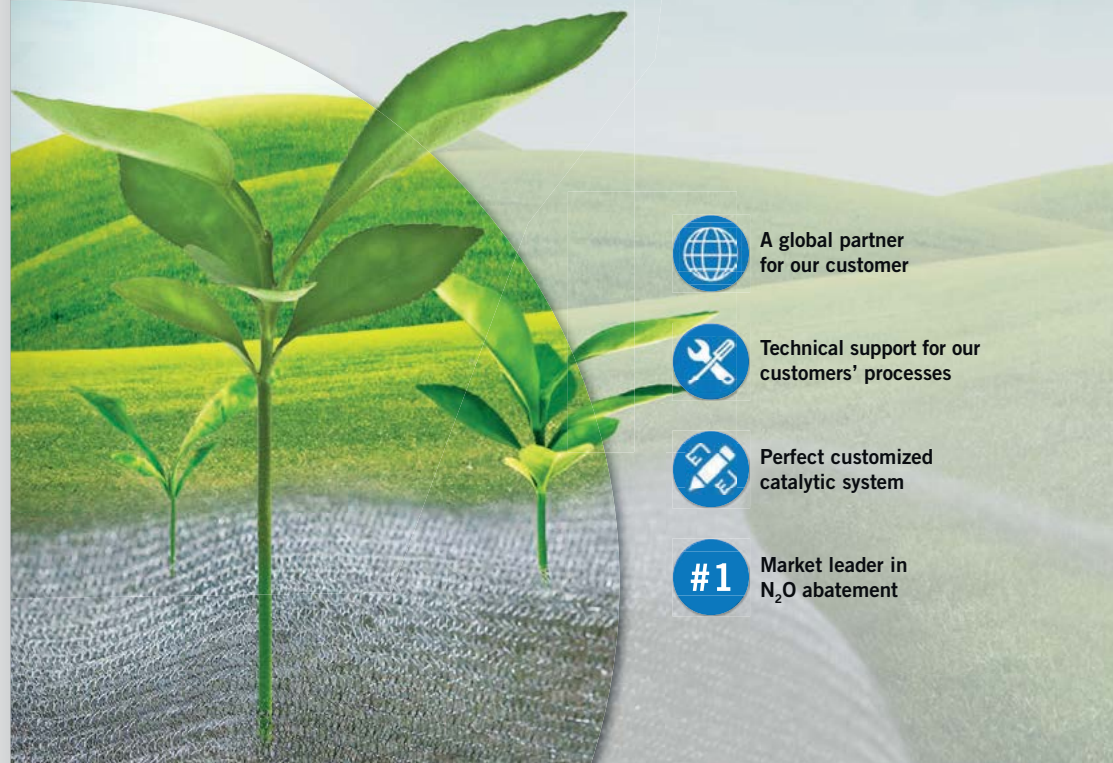

A global partner for our customer



Technical support for our customers' processes



Perfect customized catalytic system



Market leader in N₂O abatement

Heraeus Precious Metals
www.heraeus-chemicals.com
chemicals@heraeus.com

EMEA
Heraeus Deutschland GmbH & Co. KG
Heraeusstr. 12-14
63450 Hanau, Germany
Phone: +49 6181 35-4463

AMERICAS
Heraeus Precious Metals North America LLC
15524 Carmenita Road
90670 Santa Fe Springs, CA, USA
Phone: +1 727 447-2084

APAC
Heraeus Materials Singapore Pte. Ltd.
Block 5002, Ang Mo Kio Avenue 5
Singapore 569871
Phone: +65 8121 8324

CHINA
Heraeus Materials Technology Shanghai Ltd.
No. 1 Guangzhong Road, Minhang District
201108 Shanghai, China
Phone: +86 21 3357-5512

INDIA

Topsoe to license Indian ammonia plants

Further to last week's news of Technip being awarded the EPC contracts to build two new fertilizer complexes for Hindustan Urvarak and Rasayan Ltd. (HURL) – a joint venture between Coal India Ltd, NTPC and the Indian Oil Corp, as well as the Hindustan Fertilizer Corporation Ltd and Fertilizer Corporation of India Ltd (*Nitrogen+Syngas* 354, July/August 2018, p13), the ammonia technology license for the two 2,200 t/d ammonia plants has been awarded to Haldor Topsoe. Topsoe will also provide engineering support. The two fertilizer complexes in Sindri and Barauni will each comprise 2,200 t/d ammonia and 3,850 t/d urea plants and will be realized by TechnipFMC and their consortium partners L&T Hydrocarbon Engineering.

"We are extremely pleased to be able to continue our long-standing support of the Indian government's efforts towards self-sufficiency in urea production and as a consequence: food security. Our world-leading ammonia technology and catalysts are the basis for three out of the four fertilizer plant revival projects in India right now," said Amy Hebert, executive vice president and deputy CEO, Topsoe.

The two new plants are part of the Indian government's revival plans for the fertilizer sector to ensure Indian self-sufficiency in urea fertilizers. In 2015, Topsoe was awarded the ammonia technology license, basic engineering, technology, and catalysts for an ammonia plant for the Ramagundam Fertilizer Project. This 2,200 t/d ammonia plant is also a revival project scheduled to begin operation in the fourth quarter of 2018.

Coal gasification plant looking at 2022 commissioning

India's Minister for Petroleum & Natural Gas Dharmendra Pradhan has told local media that the "fast tracked" Talcher Fertilizer project at Odisha is on track for commissioning in 2022. It will be India's first operational coal gasification-based urea plant since the shutdown of the Talcher and Ramagundam plants in the 1990s, and aims to produce 1.27 million t/a of urea at a total investment cost of \$1.7 billion. The operating company, Talcher Fertilizers Limited (TFL), is a joint venture between the Gas Association of India Ltd, Coal India Ltd, Rashtriya Chemicals and Fertilizer and the Fertilizer Corporation of India Ltd. Environment clearance and selection of coal gasification technology are some of the key milestones achieved, according to Pradhan. Bids are now under evaluation for the coal gasification unit and other major tenders for ammonia and urea plants have also been floated. The plant has been allotted the output from a nearby coal mine in the Talcher region. Mine development activity has begun and to ensure a steady supply of feedstock. Site preparation is expected to begin at Talcher within a month.

Genetec scraps urea plans

Malaysia's Genetec Technology Bhd says that it decided not to proceed with a joint venture plan to to develop an ammonia-

urea plant in India. In a filing to the Malaysian stock exchange, the industrial equipment manufacturer said it had been unable to ascertain the technical feasibility and economic viability of the proposed project. Genetec had previously signed a memorandum of understanding in January with prospective project partners the Malay Chamber of Commerce, China Rainbow International Investment Co Ltd and Indian-based VBC Fertilisers & Chemicals Ltd for the proposed development.

UKRAINE

Severodonetsk Azot re-starts AN production

Severodonetsk Azot produced its first thousand tonnes of ammonium nitrate on August 1st, according to the company. The successful re-start of the AN plant follows an earlier re-start for the site's ammonia plant. Production at Severodonetsk, which lies just 30km from the Russian-occupied Luhansk Republic, was interrupted by fighting in 2014 which cut electricity supplies. Since then the facility managed to re-start in 2017 but at very low rates as gas – most of which comes over the border from Russia – was in short supply. In April 2018 an electrical fault shut the facility again. The plant, part of the Ostchem/Group DF empire, run by Dmitry Firtash, is now planning to recommission urea production.

Ukraine loses anti-dumping case

Russia has won an anti-dumping case brought against Ukraine at the World Trade Organisation, in a long-running case involving the production of ammonium nitrates fertilisers. The WTO's dispute settlement panel ruled largely in favour of Russia's 2015 complaint against Ukraine that Ukraine had acted unlawfully by including privately held Swiss-based producer EuroChem – owned by Russian businessman Andrey Melnichenko – within the scope of the measures, despite previous rulings by its own courts that the company's dumping margin in the original investigation period was negligible.

WORLD

Market growing for controlled release fertilizers

The global market demand for controlled- and slow-release specialty fertilizers is growing significantly and currently valued at \$2.35 billion, as global populations continue to increase rapidly while the amount of arable land per-capita simultaneously declines. At the same time, changing climate patterns leading to extreme drought conditions or untimely rainfalls are driving a greater focus on sustainable agriculture, according to new report from IHS Markit. Led by China, the US, Western Europe and Japan, global demand for these specialty fertilizers currently stands at more than 1.5 million t/a in 2018, and is expected to grow to at a rate of nearly 6% from 2017 to 2022. Chinese consumption, in particular, has been increasing significantly in recent years, and is projected to grow at nearly 10% annually over the period. China currently consumes approximately 700,000 t/a of these specialty chemicals or nearly 46% of the global total, while the US consumes approximately 560,000 t/a, or nearly 37% of the global total. Western Europe's share is 10% and Japan's 8%. China is also the world's leading producer of these chemicals, having aggressively expanded its production during the past five years, to reach nearly 6 million t/a annually.

Nitrous oxide emissions auction

The World Bank will be holding another auction of carbon credits in winter or spring 2019 as part of its Nitric Acid Climate Auctions Program (NACAP), in collaboration with the Nitric Acid Climate Action Group. The

NACAP will support price guarantees for eligible nitrous oxide emission reductions from nitric acid plants with existing or new abatement projects, and will sell put options to private sector companies giving the option holder the right, but not the obligation, to deliver eligible carbon credits to the NACAP in the future. In this reverse auction, eligible bidders will compete to determine the level of the put option strike price (the price guaranteed upon redemption for delivery of eligible carbon credits). It is anticipated that the starting price will be between \$8-15. The definitive starting price will be published later in 2018. Auction winners will have to pay an option premium of 6 cents per carbon credit up front to purchase the put options.

Carbon credits will have to satisfy a set of eligibility criteria at the time of redemption. Country eligibility will be determined by the NACAG. A host country eligible for funding will agree to a formal statement of undertaking with the NACAG to ensure that from January 2021, all nitric acid production installations located in the country will be equipped with state-of-the-art technology to remove N₂O emissions from their production cycles. It is anticipated that eligi-

ble carbon credits will have to be Certified Emission Reductions (CERs) or Verified Carbon Standard (VCS) Verified Carbon Units (VCUs), from a project or program of activities that uses one of the methodologies related to nitrous oxide abatement from nitric acid production.

SWITZERLAND

Clariant expands catalyst portfolio to offer NOx reduction by SCR NOx

Clariant has expanded its EnviCat series of catalysts to include a high-performance solution for selective catalytic reduction (SCR) to combat nitrogen oxides (NOx). The catalyst, an extruded honeycomb structured block made from a vanadium based composite, is designed to facilitate NOx reduction reactions in an oxidising atmosphere. With high selectivity, it significantly decreases NOx levels using ammonia as a reducing agent for the conversion of NOx into nitrogen and water, and allows the achievement of plant specific emission limit targets while controlling ammonia slip under low to medium temperature operation.

"Clariant is delighted to be able to offer this important addition to our catalyst emissions reduction portfolio," said Stefan Heuser, Senior Vice President & General Manager, Catalysts. "Not only is the technology highly effective in mitigating the dangerous effects of NOx, it now enables us to provide our customers with cost-effective emissions solutions for both upstream and downstream businesses."

BRUNEI

Ground broken on new nitrogen complex

Construction at Brunei's new \$1.8 billion nitrogen fertilizer plant is now officially under way after a ground breaking ceremony at its 55-hectare site at the Sungai Liang Industrial Park. Brunei Shell Petroleum (BSP) has agreed to supply the state-owned Brunei Fertiliser Industries (BFI) with 500 billion cubic feet of natural gas over the next 20 years to produce fertilizer, which is targeted to be exported to the agriculture industry in the region. Once complete, the facility will have 2,200 t/d of ammonia capacity and 3,900 t/d of urea,



Schoeller-Bleckmann Nitec, Hauptstrasse 2, A-2630 Tornitz, P: +43/2630/319-0, F: +43/2630/319-19, E: sbn@christof-group.com, I: www.christof-group.com

Simply look out for the best

You will find that urea equipment manufactured by SBN is simply the best you can get, because we combine up to date technology and craftsmanship to build our unique high-pressure equipment for the urea synthesis.

Designed to the specifications of our customers in the fertilizer world, our equipment is manufactured in accordance with all recognized international standards.

We design and build customized urea reactors, high pressure strippers, condensers and scrubbers as well as all other urea-grade components such as internals, piping and fittings. That gives our customers a single-source supplier of highly reliable equipment that conforms to specification.

So for your next urea needs, come to SBN.



CONTENTS

What's in issue 355

COVER FEATURE 1

India's 'methanol economy'

COVER FEATURE 2

Industrial grade ammonium nitrate

COVER FEATURE 3

Technology integration

COVER FEATURE 4

Inert catalyst support

NITROGEN+SYNGAS
ISSUE 355
SEPTEMBER-OCTOBER 2018

BCInsight

Southbank House, Black Prince Road
London SE1 7SJ, England
Tel: +44 (0)20 7793 2567
Fax: +44 (0)20 7793 2577
Web: www.bcinsight.com
www.bcinsightsearch.com

making it one of Southeast Asia's largest fertilizer plants. The EPC contract is being handled by thyssenkrupp Industrial Solutions (tkIS), who are also providing their ammonia technology.

"The fertiliser project is the start of a new era of sustainable fertiliser production in Brunei which will further strengthen the country's key industry – oil and gas," said tkIS Brunei CEO Joerg Schiemann. "Both ammonia and urea are high quality nitrogen fertilisers; essential nutrients for plant growth and therefore key to sustainable agriculture."

NIGERIA

Inorama breaks ground on second train

On July 17th, the president of Nigeria's Senate, Bukola Saraki laid the foundation stone for the construction of the second ammonia-urea train at the Inorama Eleme Fertiliser and Chemicals Ltd site in Rivers State. Rivers State Governor Nyesom Wike said that the \$3.2 billion project confirmed that the state is a destination for investors. Train 2 will be a duplicate of the 1.5 million t/a Train 1.

Saraki used his speech to call for national unity, pointing out that the urea produced on the Atlantic coast is used by farmers in the north of the country. "That tells us that we must unite," he said. "We must support ourselves irrespective of party affiliation. Without peace, there will be no urea. For all of us in Nigeria, let's work in the interest of our country." He also noted that Nigeria cannot diversify its economy without developing its agricultural sector.

Notore looks to Mitsubishi for second plant

Notore Chemical Industries has announced plans to partner with Mitsubishi Corporation of Japan and other international investors for the construction of a new ammonia-urea train at the company's facility at Onne, Rivers State. Group managing director/chief executive officer Onajite Okoloko says that preliminary studies have begun for the construction of the second, 1 million t/a train at the company's existing site, which currently has 500,000 t/a of urea capacity. The company is also looking at a 500,000 t/a methanol plant. Okoloko said that Notore's gas supply agreement with Nigerian-based oil and gas producer Eroton Exploration and Production has given it the confidence to proceed with the second train.

GERMANY

Cooperation for sustainable fertilizer production

Morocco's OCP has signed a memorandum of understanding (MoU) with the Fraunhofer Institute for Microstructure of Materials and Systems IMWS in Halle, to work jointly on solutions for a sustainable fertilizer industry, focusing on 'green' hydrogen and ammonia production via electricity from renewable sources. Under the leadership of the Fraunhofer Institute, a pilot plant is already being built in Leuna to produce hydrogen from renewable sources, and make it available for a group of companies based there from 2019. A 'green ammonia' project, will be developed in Morocco by OCP Group and the Green Energy Park in Ben Guerir, with the support of Fraunhofer IMWS. As part of the new cooperation agreement, the possible establishment of an African Institute for Solar Ammonia was also discussed.

At the signing, Prof. Ralf B. Wehrspohn, director of the Fraunhofer IMWS, said: "Green hydrogen and green ammonia offer tremendous potential to sustain the supply of raw materials to the fertilizer industry. They also reduce the industry's dependency on oil, natural gas and any other fossil fuel."

Industrial-scale electrolysis units to produce renewable hydrogen

Germany's thyssenkrupp has launched a new industrial-scale water electrolysis technology to make hydrogen production economically feasible for large projects using renewable energy including ammonia production. The company says that it has developed an economical electrolysis unit that can produce hydrogen on large scales using a large active cell area of 2.7 m² with an efficiency greater than 82% through "zero-gap" technology, where almost no gap is left between the membrane and the electrodes.

Sami Pelkonen, CEO of the electrolysis and polymers technologies business unit at thyssenkrupp Industrial Solutions said: "With our water electrolysis process, we have successfully brought a technology to market maturity which is of major significance for the energy transition. Green hydrogen as a clean, CO₂-free starting point can be used in a variety of ways: for energy storage, mobility, and the production of sustainable chemicals."

The technology is available in pre-fabricated skid-mounted modules so that it can easily be deployed and integrated into

existing plants. The modules can add up to any desired project range, potentially into the range of hundreds of megawatts. The technology has already been commissioned successfully as part of thyssenkrupp's Carbon2Chem project, which aims to use emissions from steel production as raw material for chemical production.

KAZAKHSTAN

Kazakhstan looks to Chinese money for chemical complex

Kazakhstan's KazAzot JSC will join with China's Inner Mongolia Berun Holding Group Co. Ltd to build a \$2.8 billion gas chemical complex worth in Kazakhstan's Aktau city, according to local media reports. Deputy head of government for the Mangystau region Sholpan Ilmukhanbetova said that the project is due to begun work in the second half of 2018, and will be developed in three stages. The first will produce 400-600,000 t/a of nitrogen fertilizers and methanol, and will also include a gas-fired power plant with a capacity of 300MW. Further stages will add capacity to a planned 1.2 million t/a of nitrogen fertilizers (presumably urea) and 600,000 t/a of methanol. Ownership will be 61% for Inner Mongolia Berun and 39% for KazAzot.

ISRAEL

KBR to revamp Haifa Chemicals' nitric acid plant

KBR says that it has been awarded a plant revamp contract by Haifa Chemicals Ltd. for its nitric acid plant in Mishor-Rotem. KBR will provide a complete system for the selective catalytic reduction (SCR) of nitrogen oxides, with additional catalyst beds for N₂O and NH₃ slip abatement. The SCR system will be integrated into two existing nitric acid plants operated by Haifa with capacities of 240 t/d and 147 t/d respectively.

CORRECTION

In our Nitrogen Project Listing, in the *Nitrogen+Syngas* 352 (March/April 2018), p31, we incorrectly stated the licensor for the Deepak Fertilizers and Chemicals nitric acid/ammonium nitrate plant in India was thyssenkrupp Industrial Solutions. In fact the licensor for both plants is Casale SA. We apologise to both companies for the error.

Catalyst and Getter Systems As Unique as Your Plant

Your Single Source for SCS Catalyst and SRS Getter Systems Filter, Cleaning and Destructive Precious Metal Recovery

- Multi-dimensional catalyst systems, highly customizable for each plant
- Getter systems designed for high efficiency and low pressure drop
- Precious metal recovery from filters, sludges, sweeps and vacuum cleaners
- Non-destructive cleaning of plants and components including metal refining
- Destructive recovery of precious metals from redundant or decommissioned plant equipment



Contact us for a free consultation: evaluation@sabinmetalcop.com



sabin
METAL CORPORATION
Nitric Acid Group
Scottsville, NY 14546 USA
Telephone: 585-538-2194

CONTENTS

What's in issue 355

COVER FEATURE 1

India's 'methanol economy'

COVER FEATURE 2

Industrial grade ammonium nitrate

COVER FEATURE 3

Technology integration

COVER FEATURE 4

Inert catalyst support

NITROGEN+SYNGAS
ISSUE 355
SEPTEMBER-OCTOBER 2018

BCInsight

Southbank House, Black Prince Road
London SE1 7SJ, England
Tel: +44 (0)20 7793 2567
Fax: +44 (0)20 7793 2577
Web: www.bcinsight.com
www.bcinsightsearch.com

CHINA

Tariffs on methanol may damage the industry

In responding to US tariffs imposed by the Trump administration on Chinese goods, including methanol, China has announced its own slate of retaliatory tariffs on US goods, and this could include a 25% tariff on imported methanol. In Washington, the Methanol Institute (MI) has strongly urged the US Trade Representative to remove methanol from its list of 6,000 products of Chinese goods, as there are no US imports of methanol from China, but Chinese retaliation would impose additional tariffs on US methanol export at a time when the US is making what the MI calls "a critical transition from being a net methanol importer, to becoming a net methanol exporter, and one of the principal potential markets for US methanol exports is China." However, US exports of methanol to China are still currently quite small, and market watchers say that they do not expect any short term impact on c.f.r methanol prices in China. China imported 8.1 million t/a of methanol in 2017, but more than half came from the Middle East, and only 68,000 tonnes from the US. The US exported over 1.5 million t/a last year, most of it to South Korea.

The main impact may come on new plants – Chinese-based Northwest Innovations is trying to secure permission to build two huge methanol plants in the US Pacific Northwest which would be geared at exporting methanol to Chinese methanol to olefins producers. Meanwhile Fluor, which had been hoping to build a \$3.8 billion methanol project at Lake Charles in Louisiana, says that it may have to delay or cancel the project if the US imposes a tariff on components for critical pieces of equipment such as air separation units. While the ASU would be designed and supplied by a US company, certain components for it "are only available from China," according to Fluor. The American Chemistry Council has also strongly opposed any tariffs involving chemicals, particularly in light of \$194 billion in announced investments in US chemical manufacturing, and has asked the Trump administration to remove all chemicals and plastics from the \$16 billion list of affected goods in the second round of tariffs on top of those for steel and aluminium imposed in March.

Praxair completes two air separation units in China

Praxair has started production at two new air separation plants to supply the China National Offshore Oil Corporation (CNOOC) with oxygen and nitrogen. With a capacity of 2,400 t/d of oxygen each, the two facilities will support CNOOC's refinery expansion and downstream chemical production. Praxair China president Will Li said: "This project not only expands our relationship with CNOOC, but also enables us to build density and increase supply reliability to all of our valued customers in the park and throughout southern China. Praxair is driving further profitable growth through disciplined investment in select projects such as this one."

Honeywell PSA plant to recover hydrogen for MEG

Honeywell says that Hubei Sanning Chemical Industry Co., Ltd. will use Honeywell UOP's Polybed™ pressure swing adsorption (PSA) technology to supply high-quality hydrogen at its monoethylene glycol (MEG) plant at Zhijiang in Hubei Province. The Hubei Sanning plant gasifies coal to produce MEG – commonly used to make polyester resins, films and fibres. The PSA plant will recover 165,000 Nm³/h of hydrogen from the intermediate syngas stream at very high purity (99.9999%) via the use of new UOP adsorbents, helping the plant to meet new environmental requirements and forming part of a modernisation to

high pressure gasification to accommodate a new 600,000 t/a MEG plant which is due to begin operations next year.

"This is the first application in China of the Honeywell UOP PSA technology in an MEG chemical plant," said Henry Liu, regional general manager for Honeywell UOP China. "It demonstrates the flexibility of Honeywell UOP's hydrogen technologies in a wide range of uses, including chemical manufacturing."

INDIA

New hydrogen plant for Hindustan Petroleum

TechnipFMC says that it has been awarded a contract by state-owned Hindustan Petroleum Corp Ltd for a new hydrogen plant. The plant is part of a brownfield expansion at HPCL's Visakh refinery in Visakhapatnam, Andhra Pradesh. Technip's contract covers project management, technology licensing, preparation of basic design and engineering package, as well as detailed engineering, procurement, construction, commissioning, and performance guarantee test run. The hydrogen unit comprises two trains each with a design capacity of 113,000 t/a, and a pressure swing adsorption unit of 36,000 t/a, and will allow the refinery to increase its throughput from 8.3 million t/a to 15 million t/a.

The unit will use Technip's proprietary TechnipFMC Parallel Reformer (TPR™), a convective, high temperature heat exchange

reformer in parallel with a conventional steam reformer which reduces overall firing demand by taking high temperature heat from the effluent of the conventional reformer to supply heat needed for the TPR. In addition, the design includes a power generation unit that uses excess steam, making the plant electrically self-sufficient.

AUSTRALIA

Feasibility study for hydrogen/ ammonia plant

Australian hydrogen infrastructure company Hydrogen Utility™ (H2U) has tasked with performing a feasibility study for a new hydrogen project using renewables. The proposed project would include a 30MW water electrolysis unit as well as a 50 t/d ammonia plant, both based on thyssenkrupp technology, at a site near Port Lincoln in South Australia. A 10MW hydrogen-fired gas turbine and 5MW hydrogen fuel cell would supply power to the grid.

Dr Attilio Pigneri, CEO of H2U said: "This project is an important milestone for Australia's shift to a reliable renewable energy future. The new facility will provide balancing services to the national transmission grid, fast frequency response support to new solar plants under development, supply green ammonia and other chemicals to the local farming and aquaculture sectors. It will host the demonstration of novel supply chain technologies for the export of green hydrogen to markets in the Asia-Pacific region."

Sami Pelkonen, CEO of the Electrolysis & Polymers Technologies business unit of thyssenkrupp Industrial Solutions added: "we are very excited to work together with H2U in their projects to support Australia on its way into a sustainable future."

Northern Oil to feed fuel cell from waste gas hydrogen

Northern Oil is to install a hydrogen fuel cell at its Yarwun "biorefinery" in Queensland, running it off hydrogen extracted from the plant's waste gas stream. The fuel cell, to be supplied by UK-based AFC Energy, will be run for two years as a test, and if deemed viable the company expects to install a full-scale hydrogen fuel cell which is expected to produce 200-400MW of electricity at a cost 20% lower than the current electricity price that the company pays.

The Yarwun 'biorefinery' takes waste products from sugar cane processing, sawmills and food waste as well as "end of life products" like old tyres and plastics and uses pyrolysis or hydrothermal liquefaction and/or a gasifier to convert them into liquid distillates, solid 'char', and a hydrogen-rich waste gas stream.

Hydrogen innovation hub

The Australian Renewable Energy Agency (ARENA) has announced an A\$1.5 million grant (US\$1.1 million) to fund Australia's first "green hydrogen" innovation hub at Jandakot in Western Australia. At Jandakot, Australian gas utility company ATCO will trial the production, storage and use of renewable hydrogen to feed a commercial-scale 'microgrid'. Hydrogen will be produced from on-site solar panels using electrolysis, and will be used to fuel a range of gas appliances, as well as blending some hydrogen into the natural gas pipeline. The A\$3.3 million (US\$2.5 million) development project will also evaluate the potential for renewable hydrogen to be exported at a larger scale.

UNITED STATES

KBR wins FEED contract for Geismar 3

Methanex has awarded the front end engineering and design (FEED) contract for its proposed new third methanol plant at Geismar, Louisiana to KBR. The 5,000 t/d (1.65 million t/a) plant would be built next to Methanex's two existing plants at the site, which were relocated from southern Chile, where Methanex had faced gas supply issues. Methanex has also awarded a reimbursable engineering, procurement and construction management (EPCM) contract to KBR, assuming that a final investment decision goes ahead. KBR says that it expects FEED work to take 12 months, and Methanex will make a final investment decision in mid-2019. The new plant would take Methanex's methanol production capacity at Geismar to 3.7 million t/a.

BASF teams with AI company to develop new catalysts

BASF is teaming up with AI development company Citrine Informatics to use machine learning techniques to accelerate the development of new environmental catalyst technologies. The preliminary phase of the pilot project will focus on identifying new materials for capturing greenhouse gases, like carbon dioxide (CO₂). BASF will provide experimental data to build proprietary AI models using the Citrine platform. By iteratively testing newly suggested materials from the models in the lab, BASF and Citrine aim to improve the models through sequential learning by retraining the algorithms with new data.

"We strongly believe that combining our technical knowledge and experimental data with AI can accelerate material discovery,"

WE CONVEY QUALITY

High Performance Bucket Elevators



AUMUND Chain and Belt Bucket Elevators

- For the Fertilizer, Minerals and Cement Industry
- Efficient transport of any kind of bulk material



AUMUND Foerdertechnik GmbH
minerals@aumund.de · www.aumund.com



CONTENTS

What's in issue 355

COVER FEATURE 1

India's 'methanol economy'

COVER FEATURE 2

Industrial grade ammonium nitrate

COVER FEATURE 3

Technology integration

COVER FEATURE 4

Inert catalyst support

NITROGEN+SYNGAS
ISSUE 355
SEPTEMBER-OCTOBER 2018

BCInsight

Southbank House, Black Prince Road
London SE1 7SJ, England
Tel: +44 (0)20 7793 2567
Fax: +44 (0)20 7793 2577
Web: www.bcinsight.com
www.bcinsightsearch.com

said Dr. Mengting Yu, who leads digitalization initiatives in heterogeneous catalysis at BASF. "The model rapidly screens thousands of new materials and becomes smarter in its predictions. We are looking forward to extending our collaborations into other catalysis applications."

US gas production could grow by 60% to 2040

A decade since the start of the shale gas revolution that unlocked new supplies and resulted in a wholesale turnaround in US gas production, the overall size of recoverable gas reserves continues to increase and the pace of production growth is only accelerating, according to a new report by business information provider IHS Markit. IHS says that it expects US natural gas production to rise by almost 8 bcd/day, more than 10%, in 2018 alone, and that it expects it to grow by another 60% over the next 20 years. Additionally, IHS Markit now estimates that approximately 1,250 trillion cubic feet of US supply is economic at prices below \$4.00/MMBtu Henry Hub price today. In contrast to the assumptions of a decade ago, the US is now on track to become one of the world's major LNG exporters. IHS expects US LNG export capacity to more than double in the next five years and rise to at least 10 Bcf/d by 2023. By 2040, the company says it expects natural gas' share of power production to grow from almost one-third to nearly half of all electricity generated in the US. This has also had a knock-on effect on US CO₂ emissions, which were down 30% in 2017 compared to 2005, and more than half of that emission decline was from gas replacing coal.

Looking downstream, IHS estimates that more than \$120 billion in new capital investments will be spent from 2012-2020 to expand US petrochemical manufacturing capacity as a result of abundant and inexpensive natural gas and natural gas liquids.

CANADA

Large scale carbon capture for XTL production "feasible and affordable"

Canadian clean energy developer Carbon Engineering says that it has published new research which proves that CO₂ can now be captured from the atmosphere for less than US\$100/t. The company says its Direct Air Capture (DAC) technology demonstrates for the first time "a scalable and cost-effective solution for removing CO₂ from the atmosphere". The research

was led by David Keith, a Harvard professor and founder of Carbon Engineering, based on three years' results from the company's pilot plant in Squamish, British Columbia. The company now aims to now commercialise its DAC technology via integration with the company's *AIR TO FUELS*[™] process, which uses hydrogen from water electrolysis and captured carbon dioxide. These are then catalytically reacted to produce syngas, which can then be used for Fischer-Tropsch synthesis to produce liquid hydrocarbons. Carbon Engineering says that it has been successfully running the latter process at its pilot plant since December 2017. However, at a cost of \$100/t of CO₂ feedstock, its ability to cope with existing natural gas-based processes would be heavily dependent on environmental subsidies and carbon taxes. The company says that the next step is to demonstrate the scalability of the technology, and that it is "actively seeking partners who will work with us to dramatically reduce emissions in the transportation sector and help us move to a carbon-neutral economy."

NEW ZEALAND

Methanex signs new gas supply deal

Methanex says that it has secured at least half of its gas supply requirements until 2029. The company said in a statement that this would "underpin over half of Methanex's 2.4 million t/a of production capacity in New Zealand for a period of 11 years". However, it still leaves the future of Methanex's methanol production in the country uncertain. Methanex has faced persistent issues in sourcing gas for its plants, and was forced to shut some of them down in the late 2000s, and while new gas discoveries allowed it to reopen the Waitara Valley plant in 2013 and refurbish two plants at the nearby Motonui facility, long term gas supply remains an issue. This was exacerbated when the New Zealand government announced an end to new offshore oil and gas exploration permits in April this year, which could have left Methanex, New Zealand's largest gas consumer, short of gas from 2021, and possibly leading it to shut down its Taranaki plants by 2026. While the new agreement covers 50% of Methanex's needs, this still could leave a shortfall going forward.

Dean Richardson, Methanex New Zealand managing director said: "We're delighted to secure these agreements which provide confidence in our operations

in Taranaki through 2029. We continue to be disappointed over the Government's surprise halting of offshore oil and gas exploration and if this policy remains in place it will eventually have a negative effect on our business and New Zealand's economy."

NETHERLANDS

Feasibility study for hydrogen plant

Jacobs Engineering Group has been awarded a feasibility study contract from Equinor Energy AS to evaluate the possibilities for building a hydrogen plant, including CO₂ capture and export facilities, in Eemshaven, the Netherlands. The hydrogen will be supplied as fuel to an existing natural gas-fired power plant that will be converted into a hydrogen-fuelled power plant designed to lower the plant's carbon emissions at a large scale. The award of the feasibility study follows the memorandum of understanding of Equinor, with its partners Vattenfall and Gasunie, to evaluate the possibilities of converting Vattenfall's gas power plant Magnum in Eemshaven into a hydrogen-powered plant.

The feasibility study will focus on selecting the most effective reformer technology for hydrogen production together with a suitable CO₂ capture technology. Jacobs will also deliver the conceptual design of the plant as a basis for economic evaluation and further project definition. In order to avoid CO₂ emissions from the hydrogen production process, up to 3 million t/a of CO₂ will be captured and then liquefied for transportation to Norway, where it will be injected and stored in an offshore reservoir. The first of three Magnum plant units should be converted to run on hydrogen by early 2024.

"Getting the opportunity to work with Equinor to study the possibilities of gas-to-hydrogen conversion and contribute to a significant CO₂ reduction is meaningful to Jacobs in many ways," said Jacobs Senior Vice President and General Manager Energy and Chemicals EMEA David Zelinski.

Methanol from gasified waste

Enerkem, which already operates an ethanol production plant in Edmonton, Alberta based on gasified municipal waste, is now planning to open a similar plant at Rotterdam, using some of the 2 million t/a of municipal solid waste shipped to the port to produce methanol through gasification. Enerkem will be partnered in the project by the Port of Rotterdam authority, Dutch

chemical company AkzoNobel, and industrial gas company Air Liquide, which will supply its Lurgi methanol license for the methanol plant. The plant, which is budgeted at \$232 million, will gasify 300,000 t/a of waste to produce more than 200,000 t/a of methanol. The process will avoid around 300,000 t/a of carbon dioxide emissions that would otherwise have been generated from simply incinerating the waste. One of the attractions of the Rotterdam site is that it is an existing methanol receiving and distribution hub. It also has potential access to very large supplies of municipal waste shipped from elsewhere in Northern Europe or the UK.

"All four partners have complementary strategies, with the main one being to work on shifting from fossil fuels to alternative fuels," said Anton de Vries, an Enerkem director who leads the project. AkzoNobel is a methanol consumer for acetic acid and resins production, and is looking to switch to more sustainable raw materials. The Port of Rotterdam meanwhile is committed to the Dutch government's target of reducing greenhouse gas emission levels by 49% in 2030 (compared to 1990 levels) and 95% by 2050.

The plant is currently in the design phase, with construction due to begin sometime in 2019 and completion set for 2020. The company's eventual plans are to use this as a template for other similar plants, having modules constructed in different parts of the world to be assembled in Rotterdam and shipped out.

GERMANY

Messer to build new hydrogen plant

Messer Group GmbH has signed a 15-year hydrogen supply contract with Rütgers Germany, a subsidiary of Rain Carbon Inc. As a result Messer will now invest a total of €9 million to build a hydrogen production facility – its first in Germany – at the site of Rain Carbon Inc. in Castrop Rauxel. Rain Carbon will use the hydrogen in the manufacture of industrial resins. Messer will also use the facility to supply other hydrogen customers in the region. The steam reforming-based facility will use natural gas as feedstock and will have a capacity of 2,700 Nm³/h. Start-up of the hydrogen plant is planned for the third quarter of 2019.

MALAYSIA

Sarawak Energy trialling hydrogen plant and refuelling station

Sarawak Energy has broken ground on a new hydrogen pilot production plant and refuelling station to evaluate the viability of using hydrogen and fuel cells to power the transportation sector in Kuching in the future. The plant is scheduled for completion in the first quarter of 2019, and the associated refuelling station will be the first dedicated for transportation in Southeast Asia. Sarawak Energy is building the facility in partnership with Linde Malaysia. The two corporations also signed a memorandum of understanding to explore potential markets for hydrogen, and to undertake a joint technical study to assess the technology of the whole value chain.

At the ground breaking ceremony, Linde's Head of Regional Business Unit, Rob Hughes said: "Linde is proud to be partnering Sarawak Energy in this project contributing our knowledge and expertise as a pioneer in the entire H2 value chain. Linde has worked with partners in delivering around 150 hydrogen fuelling stations around the world and the success is now extending its focus to Asia. ■



You need hi-tech to make me.



We've got it!

We supply fans and accessories that comply with international standards for the chemical and petrochemical industries. Our engineering always takes into consideration the demands of the entire system.

- Long service life
- Extremely reliable
- High energy efficiency



We make air work for you.

- ▶ Process gas fans
- ▶ Process gas cleaning plants
- ▶ Dust collection plants
- ▶ Recycling and waste treatment plants
- ▶ Ventilating and air-conditioning plants
- ▶ Exhaust air treatment plants



info@venti-oelde.de
www.venti-oelde.com



CONTENTS

What's in issue 355

COVER FEATURE 1

India's 'methanol economy'

COVER FEATURE 2

Industrial grade ammonium nitrate

COVER FEATURE 3

Technology integration

COVER FEATURE 4

Inert catalyst support

NITROGEN+SYNGAS
ISSUE 355
SEPTEMBER-OCTOBER 2018

BCInsight

Southbank House, Black Prince Road
London SE1 7SJ, England

Tel: +44 (0)20 7793 2567

Fax: +44 (0)20 7793 2577

Web: www.bcinsight.com
www.bcinsightsearch.com

People

EuroChem has announced the appointment of **Kuzma Marchuk** as its chief financial officer. Marchuk succeeds **Andrey Ilyin**, who left the company at the end of June after 10 years in the role. Marchuk, who joined the EuroChem board of directors as a non-executive director in 2017, is also a member of the board of SUEK, where he served as deputy CEO and chief financial officer between 2011 and 2016. Before that he was CFO and, from 2007, a member of the board of directors of Uralkali. Commenting on the announcement, Dmitry Strezhnev, EuroChem Group CEO said: "I am delighted that Kuzma Marchuk will take over as our CFO. He has worked closely with the Group in the past and is well known to our financial stakeholders. I would like to thank Andrey Ilyin for his extensive contribution to EuroChem over the past decade and wish him the very best for the future." Kuzma Marchuk stated: "I am thrilled to take up this role at such an exciting time in the company's development, and I look forward to helping the Group through its next stages of growth."

Bunge Limited says that **Brian Thomsen**, president, Agribusiness, has informed the company of his intent to retire from Bunge. Thomsen will remain with the company through the end of the year in order to ensure a smooth transition. Thomsen joined



Kuzma Marchuk.

the company in 2004, and has led Bunge's Agribusiness segment since May 2014, having previously served as managing director of the global Grains and Oilseeds product lines.

"Brian's leadership, business knowledge and expertise in risk management have been instrumental to Bunge over the years," said CEO Soren Schroder. "We wish Brian all the best in his retirement and thank him for his leadership and contributions to the company. I have full confidence in our Agribusiness team to execute on the plan and deliver a strong year for Bunge."

Fertilizer Canada has announced that **Brian Mark** of Nutrien has been appointed as Chair of its Board of Directors for a two-

year term. He succeeds **Kathy Jordison** of Yara Canada LP, who has served as Fertilizer Canada's Chair since 2016. Jordison will continue to lend her industry expertise to the association by remaining an active member of the Board of Directors.

Brian Mark joined Fertilizer Canada's Board of Directors in 2012. He is a vice president in sales and brings more than 25 years of industry experience to his role as Chair. He began his career in the fertilizer industry in 1991 and has gained extensive knowledge of the North American and international fertilizer markets. He is a strong advocate for the industry and has also served on the Nutrients For Life Foundation Board of Directors.

Garth Whyte, President and CEO of Fertilizer Canada said: "As we enter the final phases of our Vision 2020 strategic plan, Brian's leadership will be instrumental in sustaining our momentum towards completing our association's goals. On behalf of the Board and staff, I would also like to thank Kathy for her exceptional leadership in her position as Chair. As a result of her steadfast commitment and guidance, Fertilizer Canada has made significant progress towards our strategic goals and has created a track to success for the benefit of the collective industry."

Calendar 2018/19

SEPTEMBER

16-20

63rd AIChE Annual Safety in Ammonia Plants and Related Facilities Symposium, TORONTO, Canada
Contact: AIChE Customer Service
Tel: +1 800 242 4363/+1 212 591 8100
Fax: +1 212 591 8888
Email: xpress@aiche.org

16-21

Ammonium Nitrate/Nitric Acid Conference, CALGARY, Canada
Contact: Hans Reuvers, BASF, Karl Hohenwarter, Borealis
Email: johannes.reuvers@basf.com, karl.hohenwarter@borealisgroup.com
Web: www.an-na.org/2018-conference

26-27

11th Carbon Dioxide Utilisation Summit, MANCHESTER, UK
Contact: Rohan Baryah, ACI
Tel: +48 61 646 7022
Email: rbaryah@acieu.net
Web: www.acieu.pl

OCTOBER

5-6

36th Annual World Methanol Conference, VIENNA, Austria
Contact: Lynn Urban, IHS Markit
Tel: +1 303 397 2801
Email: Lynn.urban@ihsmarkit.com

23-25

IFA Crossroads Asia-Pacific Conference, SINGAPORE
Contact: IFA Conference Service, 28 rue Marbeuf, 75008 Paris, France
Tel: +33 1 53 93 05 00
Email: ifa@fertilizer.org

28-30

Gasification and Syngas Technologies Meeting, COLORADO SPRINGS, USA
Contact: Gasification and Syngas Technologies Council, 3030 Clarendon Blvd. Suite 330 Arlington, VA 22201 USA
Tel: +1 703 276 0110
Fax: +1 703 276 0141
Email: info@gasification-syngas.org
Web: www.gasification-syngas.org

NOVEMBER

28-29

European Mineral Fertilizer Summit, AMSTERDAM, The Netherlands
Contact: Mado Lampropoulou, ACI
Tel: +44 (0)20 3141 0607
Email: mlampropoulou@acieu.net

JANUARY 2019

28-30

Fertilizer Latino Americano, MEXICO CITY, Mexico
Contact: CRU Events, Chancery House, 53-64 Chancery Lane, London WC2A 1QS, UK
Tel: +44 (0) 20 7903 2444
Fax: +44 (0) 20 7903 2172
Email: conferences@crugroup.com

MARCH

4-7

Nitrogen+Syngas 2019, BERLIN, Germany
Contact: CRU Events
Tel: +44 (0) 20 7903 2444
Fax: +44 (0) 20 7903 2172
Email: conferences@crugroup.com

—INTRODUCING— —A—NEW—NAME— —IN—INDUSTRIAL— —PROCESS— —SOLUTIONS—

IPCO is a new name in Industrial Process solutions but a business partner with whom many in the fertilizer industry will already be familiar.

Previously operating as Sandvik Process Systems, we are now an independent company within the Wallenberg group, a business with approx. 600 000 employees and in excess of €140 billion in total sales of holdings.

We continue to develop customized solutions for the fertilizer industry, with the same people, skills and process systems – including our world-renowned Rotoform® pastillation process – but under a new name and brand.

Read more at ipco.com



Plant Manager+

Problem No. 50 Low vacuum pressure in the second-stage evaporator

Most urea plants operate a two-stage evaporator section. Both stages operate under vacuum pressure conditions and both pressures and temperatures are critical to achieve the right urea product quality. It is not always easy to determine the exact cause of non-optimum values for certain process parameters like, for example, low vacuum pressure in the second-stage evaporator. Many factors can influence this vacuum pressure as discussed below.

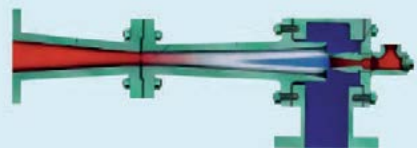

Source: Graham Corporation, USA

Mohit Bayer of CFCL Kota in India starts the discussion: In our plant we are experiencing a problem with the vacuum pressure in the final concentrator which is very low (it is now 105 mm Hg, whereas before it was 60 mm Hg). We have done all types of flushing. We have checked that air is not being sucked in through the flange connections. We have insured that the condensate outlet lines of surface condensers are not choked. The instrumentation is also okay. The urea sample moisture content is 0.56 wt-% which is not very high compared to before. The plant is TEC ACES technology running on two trains with a common prilling tower. The problem is in one train only.

- Are there any other parameters that can show that the vacuum pressure is really low?
- To what extent will this very low vacuum pressure affect the product quality?
- How can we insure that the final concentrator heat exchanger tubes are not leaking?
- What will happen to the steam consumption of the heater of the final concentrator when the vacuum pressure is low: will it increase or decrease?

The actual cause is still unknown. We have performed a lot of flushing and tried to clear the path of vapour. We have also performed a lot of polymer washing, and insured that the vacuum is not broken anywhere.

Kashif Naseem asks for some further clarifications and provides some valuable suggestions: What are the evaporator parameters? Check that the flushing valves are fully closed. Purge your surface condensers. Flush the bottom bottles of the surface condensers and check the ejectors (maybe the downstream line is choked).

Mohit replies: We have checked all of the things you suggest and all are clear. The evaporator parameters are as follows: shell-side steam pressure 2.8-3 kg/cm²g; tube-side inlet urea solution temperature 131°C; tube-side outlet urea solution temperature 136°C; tube-side pressure 50 mm Hg; flow of urea solution 60-65 m³/h; temperature of urea outlet solution is controlled by steam pressure; urea inlet to this evaporator comes from the first evaporator that is operating on 150 mm Hg vacuum, its vacuum is taken by an ejector that is in the vapour outlet of a surface condenser (say No. 3), uncondensed vapour of this condenser No.3 goes to surface condenser No.1 (condenser for first stage evaporator) whose vacuum is taken by an ejector in its downstream line; sur-

face condenser No.1 operates at 150 mm Hg and No.3 at 105 mm Hg, these two ejectors are in series; the vacuum of the first evaporator is okay.

Majid Mohammadian of OCI Nitrogen in the Netherlands shares his experiences: Vacuum in concentrators is mostly the result of cooling in the condensers, performance of the ejectors and the concentration and temperature of the urea solution. Sometimes partial crystallisation in the condensers may occur leading to a bad vacuum pressure. If the urea solution concentration is correct my suggestions are as follows: First raise the condenser temperature in the cooling water return line to about 45 to 50°C for a short time and check that there is no partial crystallisation in the condenser. Secondly check the ejector internal and its performance.

Mohit replies: We have already done what you suggest many times, we call it condenser hot flushing, but it has not helped.

Muhammad Farooq of SABIC/SAFCO in Saudi Arabia offer his suggestions: As the moisture content is quite high, it looks to me like the final concentrator may be overloaded. I would suggest checking the following: urea solution concentration in the urea solution tank downstream of the low pressure decomposer/flash tank – compare it with the design value in the mass balance (percentages of ammonia and water are important); urea solution concentration after the first evaporator/concentrator (percentage of ammonia in wt-ppm); condition of the final ejector line-up to the condenser – polymer deposition will hamper the vapour path to the surface condenser.

Does the vacuum pressure change when you carry out flushing of the final ejector line up to the condenser for 1-2 hours with hot media? Finally check physically/internally the nozzle of the final ejector of the final concentrator.

Mohit replies: The vacuum pressure in the first concentrator is within the normal range, so there is no chance of more ammonia and water in the low pressure decomposer outlet. The conditions in the back end are also the same as before. We have also done polymer flushing and because it may choke the vapour path it is done with the help of molten urea, but it makes no difference. As far as the ejector is concerned, there is no provision for flushing the ejector of the final concentrator.

Siddharth from Tata Chemicals in India shares his experience: I would like to share an improvement we made to our urea plant before shutdown of the plant during the annual turnaround of 2012. Before the turnaround, we were faced with the problem of huge deposition of polymer in the first and second stage separators of the vacuum sections. In view of this problem we started dome flushing of both separators with urea melt on a daily basis for 15 days before doing the shutdown. Even after shutdown of the plant we continued this flushing for more than 8 hours, recirculating the melt through the recovery pump. The result was splendid as much less deposition of polymer was observed in the separators and we have saved a lot of water and reduced the amount of disposal of polymer and manual work, which had been necessary earlier. In my opinion the circulation of urea melt for separator dome flushing is an important and useful activity.

Sam QR from India joins the discussion: Do you have a demister in the vapour outlet of the second stage evaporator and if so where is the pressure measurement taken, upstream or downstream? Have a routine for boiling out the second stage evaporator with 72 wt-% urea solution (once every two months). Be careful not to contaminate the evaporator condensate with urea solution, which will affect the hydrolyser. Based on the volume of the second stage evaporator/inlet solution flow rate, determine the time required to fill the second evaporator and fill the evaporator with urea solution. This will greatly help in removing poly-urea.

Evgeniy Shishkin of Koch Industries in the United States asks for further information: We are experiencing similar issues. Do you have any more information on what you mean by poly-urea and the procedure for flushing it out with urea solution?

Mark Brouwer of UreaKnowHow.com replies: Poly-urea refers to polymers of urea like biuret, triuret etc. These are formed quite easily in the second stage evaporator and dissolve easily in urea melt. Nowadays, many urea plants apply a flush system with urea melt (from discharge urea melt pump) on the second stage separator. It is of course important that these small flush lines can be flushed out when they are not in use.

Aslam Muhammad of Fauji Fertilizer Company Limited in Pakistan provides another suggestion: Please check the ejector downstream nozzles for choking or dislodgement.

Zeeshan Shoaib of Fauji Fertilizer Company Limited in Pakistan shares his experience: I will add just two more suggestions as per our own experience as we have faced similar problems. Map the temperature of the ejector and condensers from outside and observe any change. It will help to rule out the health of the ejector and condenser. Measure the cooling water flow to the vacuum section and the condensers. Back flush the condensers from the cooling water side online after by-passing the feed of vacuum section at reduced plant load. We have implemented these ideas and the poor vacuum pressure problem diminished.

Prem Baboo of National Fertilizers Ltd in India joins the discussion: The problem of second stage vacuum pressure might be due to a leakage in the vacuum system i.e. flanges of heat exchangers, condenser sight glasses, all equipment flanges. Flushing of the condensers is a temporary phenomenon, after flushing it can be improved further. There is relationship between the vacuum pressure and the separator outlet temperature. Various parameters are related to vacuum. For example if vacuum pressure is pulled out then the temperature will come down and the steam requirement increases. The moisture content in the urea product is also affected by weather conditions. The steam pressure can be increased to improve the vacuum ejectors. If there is sufficient margin in the first stage vacuum then it can be improved subject to the outlet temperature of urea and according to the concentration and temperature graph. If the outlet temperature of the first vacuum is more than 120°C then it can be increased to 225-240 mm Hg so that the load on the second vacuum is shifted to the first vacuum. The detection of leakages in the vacuum system can be checked. The procedure is tricky: two or three persons are required to check for leaks, break the vacuum pressure and all ejectors steam valve should be closed, slowly closing the condenser cooling water outlet valve. In so doing, the system pressure will increase to more than 750 mm Hg and any vapours will leak out. Observe and note down the leakage points and open the cooling water valve immediately. ■

WATCH FREE PRESENTATIONS: N, P, K, S AND S ACID MARKET OUTLOOKS

CONTENTS

What's in issue 355

COVER FEATURE 1

India's 'methanol economy'

COVER FEATURE 2

Industrial grade ammonium nitrate

COVER FEATURE 3

Technology integration

COVER FEATURE 4

Inert catalyst support

NITROGEN+SYNGAS
ISSUE 355
SEPTEMBER-OCTOBER 2018

BCInsight

Southbank House, Black Prince Road
London SE1 7SJ, England
Tel: +44 (0)20 7793 2567
Fax: +44 (0)20 7793 2577
Web: www.bcinsight.com
www.bcinsightsearch.com



Can India develop a 'methanol economy'?

India is currently engaged in a major policy discussion on greater use of alternative fuels, hoping to emulate the success of China and Brazil in substituting oil imports with domestically produced alternative fuels. Can coal-based methanol be a success there?

In Brazil, ethanol derived from sugar cane represents 18% of all transport fuel consumed in the country every year, on an energy equivalent basis. In China, methanol, mainly derived from coal feedstocks, has grown to just over 10% of the gasoline pool, in spite of strong opposition from the major state oil producers Sinopec and PetroChina. India imported 200 million tonnes of oil in 2017, and the figure continues to rise as demand for vehicle fuel continues to climb. India already imports more than 80% of its crude requirements. This has led India to begin considering whether it could duplicate or even exceed China's success with using domestically produced methanol to substitute for imports of oil.

NITI Aayog

The responsibility for developing a 'methanol roadmap' for transforming India's transport economy has been devolved to NITI Aayog. NITI Aayog is the National Institution for Transforming India. Headed by prime minister Narendra Modi, it was formed on January 1st 2015 as the premier policy 'think tank' for the Indian government, to provide both directional and policy inputs. In 2016, the Institution put together an Expert Group to begin work on developing a the methanol roadmap, with three sub-groups tackling respectively production, utilisation and R&D. This was supported by a conference in September 2016 on India's Leap Into The Methanol

Economy – Opportunities and Options for Energy Security, organised jointly with the Department of Science and Technology, the Ministry of New and Renewable Energy, and the US-based Methanol Institute.

Applications

Methanol can in theory be used in a very wide variety of applications; it can replace both petrol and diesel in road vehicles, or can be blended with existing fuel at up to 15% without requiring any modifications to existing engines, and can replace LPG, wood or kerosene as a cooking fuel. It can also replace diesel in the rail or marine environments, can be used in a power plant, and it is even possible that methanol-based reformers could complement electric or hybrid vehicles. In the power sector, India has 22,000 MW of generation capacity based on burning heavy fuel oil (HFO), one of the dirtiest fuels and one largely abandoned in most other countries. Methanol burns relatively cleanly, producing no particulate matter or soot, and very low SOX and NOX emissions. It can cut emissions by 33% compared to gasoline or 80% compared to diesel.

It is also capable of being produced from a variety of sources, including natural gas, coal (even Indian high ash coal), bio-mass, municipal solid waste and most importantly from CO₂ itself. As to cost, NITI Aayog estimates put the cost of producing methanol fuel in India at around 19 rupees per litre (\$0.27/litre or just over \$1.00/

gallon). This is 30% cheaper than any other fuel available in India.

China

China has been the model which India seeks to copy. Over the past 20 years China has vastly increased its coal-based methanol production, to the extent that China now accounts for more than 60% of all global methanol production. In addition, it also produces another 4 million t/a of dimethyl ether (DME), which is blended into LPG for domestic heating use. Methanol accounts for almost 9% of transport fuel in China, with millions of methanol-capable vehicles in circulation.

Other countries have adopted methanol fuel blending programmes, including Israel and Italy, both of which have M15 (15% methanol and 85% gasoline) fuel standards, and they are also considering introducing M85 and M100 standards. Japan and South Korea also have methanol fuel programmes, while Australia has preferred a triple blend of so-called GEM – gasoline, ethanol and methanol, with blends of up to 56% methanol. In the marine sector, ferries and tankers have been converted to run on methanol.

The roadmap

NITI Aayog has drawn up a plan to eventually replace up to 20% of India's crude oil imports from methanol alone. Currently India has only 2 million t/a of methanol pro-

duction capacity, and in the 2017 financial year produced only 210,000 tonnes. As Table 1 shows – India's methanol consumption runs currently at just under 2 million t/a. NITI Aayog's ambitious plan envisages increasing this to 20 million t/a by 2025, and 30 million t/a by 2030, by which time it would replace 10% of India's crude oil imports and potentially save \$100 billion in foreign exchange. The so-called 'roadmap' for the methanol economy includes:

- Production of methanol from Indian high ash coal in large quantities, on a region by region basis. It has also suggested the adoption of carbon dioxide capture to meet India's commitments to the COP21 climate change treaty.
- Up to 40% of methanol will be produced from biomass, stranded natural gas and municipal solid waste.
- Both methanol and dimethyl ether (DME) will be used in the transportation sector, including rail, road, ships and in the defence industry.
- Utilisation of methanol and DME as a domestic cooking fuel to replace LPG in stoves – probably including an LPG-DME blending programme.

Table 1: Indian methanol statistics, 2013-17

Financial Year	Production, t/a	Imports, t/a	Total consumption t/a
2013	255,000	n/a	n/a
2014	307,000	1,310,000	1,617,000
2015	210,000	1,639,000	1,849,000
2016	163,000	1,712,000	1,885,000
2017	210,000	1,637,000	1,847,000

Source: Government of India

- Utilisation of methanol in fuel cell applications in ships, power generation and possibly transportation.

India aims to begin with a transport fuel blending programme such as China has developed, with an M15 (15%) methanol blend into gasoline. M100 can be used in fleet vehicles like buses and trucks, which are fuelled centrally, to avoid having to initially develop a methanol vehicle fuelling infrastructure. The plan envisages collaboration with global engine manufacturers like Volvo, Mercedes and Caterpillar in conjunction with Indian manufacturers to build

methanol fuelled engines in India, generating inward investment into the country.

On the marine front, around 50 vessels in the port sector and various government-owned vessels will be converted to run on methanol – this will also help compliance with new IMO emissions regulations.

India's railways consumes about 3 billion litres of diesel fuel per year at a cost of \$2.1 billion. A methanol locomotive prototype is being developed by Indian Railways under a grant from the Department of Science and Technology. The ultimate aim would be to convert all 6,000 diesel engined locomotives to methanol which

36TH ANNUAL WORLD METHANOL CONFERENCE
Vienna, Austria | 6 October 2018 | Training Workshop, 5 Oct



Methanol-to-Olefins: Shift in Fortune Amid Low Oil?

The electrical and medical product industries are highly regulated, with thousands of standards affecting all aspects of operations.

Oil prices have been fluctuating at lower levels than in the past, potentially hampering prospects for methanol both into methanol-to-olefins (MTO) and into fuels.

How will prospects for methanol pan out in the midst of these complexities?

The 36th Annual World Methanol Conference and Workshop will outline these key issues and discuss where the opportunities are in the midst of change in a full day of content, data analysis and expert insight.

Join us and your colleagues in the methanol industry in Vienna, Austria on Oct 6, 2018 for a time of information and insight sharing, as well as networking.

Training Workshop | 5 October

Market Fundamentals, MTO and Small-Scale Methanol Plants

REGISTER NOW

www.ihsmarkit.com/WMC2018

would reduce the annual diesel bill by an estimated 50%. It is hoped that the conversion programme would also be complementary to progressive electrification of India's railways.

On the cooking fuel side, a 20% DME blending program with LPG could be achieved without any significant infrastructure modifications (provided that suitable attention was paid to seals and gaskets of LPG canisters, which can be dissolved by DME).

Progress so far

The main progress so far has been the roadmap itself. There has been some development work on conversion of different engine types as proof of concept. So far there have been conversions of a moped engine, a power generation site, fuel-powered agricultural equipment (a power weeder), and progress is ongoing with internal combustion engines for railways and ship engines. NITI Aayog is also looking at a \$710 million Methanol Economy Fund to promote methanol developments in India. The Bureau of Indian Standards has certified methanol as a fuel, with associated regulatory approvals.

Initial methanol plant developments are likely to be via existing producers like Gujarat Narmada Fertilizer Co (GNFC), Rashtriya Chemicals and Fertilizers (RCF) and Assam Petrochemicals, targeting a capacity of 5 million t/a by 2021 (requiring 3 million t/a of new production). Public sector companies like Coal India Ltd, the Steel Authority of India Ltd, Bharat Heavy Electricals Ltd (BHEL) are considering making methanol using coal gasification, while the oil sector public companies are leaning towards the use of stranded natural gas. BHEL says that it at its Trichy site it will be establishing and demonstrating the conversion of high ash coal to methanol production. The huge new Talcher Fertilizer plant, which is also based on coal gasification, could also adopt a methanol side stream with relatively few complications.

It was disclosed in June that there is also a proposal circulating at high levels of government to allocate coal blocks to national oil and refining companies such as the Indian Oil Co, Hindustan Petroleum Corporation and Bharat Petroleum Corporation, in order to allow them dedicated feedstock resources from which to produce methanol. The proposal, which has

come from the Road Transport Ministry will be submitted to the Prime Minister's office (PMO) for formal approval. Coal blocks in Odisha, Jharkhand, Chhattisgarh and Telangana provinces have been identified for allocation to the national oil companies. The Road Transport Ministry has also suggested that there should be a lower rate of India's new Goods and Service Tax of 12% rather than the existing rate of 18% for methanol sold to trucks which run exclusively on the fuel. The focus on oil and refining companies is to allow them to use their existing production and distribution networks to sell methanol as well as conventional fuels. While there is also talk of Coal India Ltd diversifying into methanol production, it is currently assumed that this would mainly be aimed at the power sector.

How realistic is this?

The plans are certainly ambitious, but are they too ambitious? There are various hurdles which need to be overcome. The first is to provide sufficient feedstock. India is chronically short of natural gas, and while it is planning to import more LNG, some of which will be used to feed the new ammonia-urea plants being built in the country, the practicalities of producing 30 million t/a from imported LNG would be incredibly difficult and prohibitively expensive. India already has gas-based methanol plants which do not operate because they are not able to produce as cheaply as methanol can be imported from Iran and other places in the Middle East. That leaves coal gasification. While India has no shortage of coal, and has reserves comparable with China, India has had a troubled history with coal gasification, with its only two coal gasification-based ammonia plants closing down in the 1990s. Although they are now planned to be revived under the government's plan to make India self-sufficient in fertilizer, along with some large new coal gasification-based ammonia-urea plants such, there is still considerable scepticism about coal gasification in India.

The second hurdle is potentially technical – Indian coal is of very high ash content, typically up to 25-45% ash. Beneficiation can reduce ash content to below 20%, but it adds extra cost. Chinese coal by comparison is generally lower ash content, although figures of 20% are not uncommon, and one plant is said to be running on coal at 38% ash content. Most gasifier suppliers indicate

that their technologies can run at these ash contents with suitable modifications, but running at such high ash contents does lead to a reduction in the gasifier's efficiency.

There is an environmental hurdle – generating 30 million t/a of methanol from gasified coal will generate large quantities of carbon dioxide, which could put India outside of its commitments under the COP-21 treaty. It has been proposed that CO₂ could be sequestered underground, but in spite of a great deal of work on this elsewhere, there are currently only a handful of working large scale (>800,000 t/a) carbon capture and storage projects and about 20 'industrial scale' (>50,000 t/a) carbon capture and storage projects worldwide, and all of the large scale ones and most of the industrial scale ones are based on reinjecting CO₂ for enhanced oil recovery (EOR). NITI Aayog has also proposed the use of biomass or municipal waste gasification. While there are some projects based on producing methanol from these sources worldwide, the largest is only 110,000 t/a, at Edmonton in Canada, based on municipal waste, and most of the others are only at the pilot plant stage. Replicating this on a large scale in India looks challenging to say the least, and biomass gasification requires more expense in gathering sufficient feedstock together.

Finally, there is a political and economic hurdle. All of this is going to cost a great deal of money – tens of billions of dollars. While there is the potential for saving in terms of oil import costs, that is in the future, while the cost of developing and building the plants must be borne now. China has – in this sense at least – benefited from its top-down and centralised planning and decision making on a political level – the government can mandate something and have it happen. India's political system is much more vulnerable to large capital projects becoming political footballs between rival parties, and India has a history of overpromising and under-delivering as regards the extent of its ability to develop large chemical plants.

The feedstock and technical barriers are not insuperable, and China has shown that the financial and political hurdles can be overcome, if there is sufficient will there, but the proof of India's genuine conversion to a 'methanol economy' will be contracts awarded and ground broken on new coal-based methanol plants, and so far there is no sign of that. ■

Seamless Syngas Solutions

We are pushing technology limits in design and delivery of syngas plants, including the world's largest units.

- Well referenced and cutting edge technologies
- Safe, efficient and reliable
- Feedback from our own operations
- Full process chain of ASU and syngas conditioning including CO Shift, Amine Wash, PSA, CO Cold Box, Membranes

H₂/CO Ratio

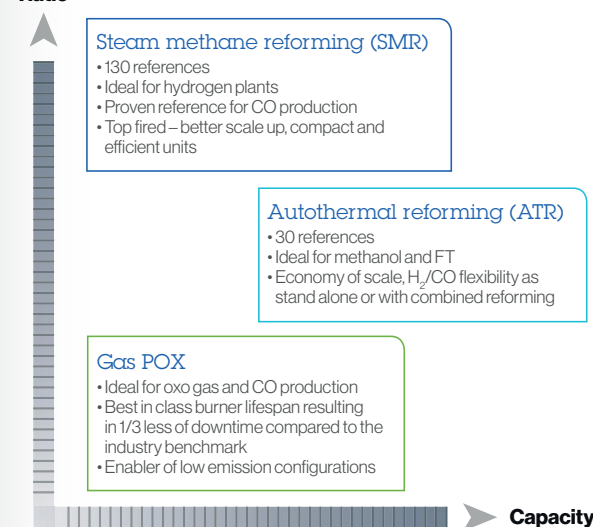

Steam methane reforming (SMR)

- 130 references
- Ideal for hydrogen plants
- Proven reference for CO production
- Top fired – better scale up, compact and efficient units

Autothermal reforming (ATR)

- 30 references
- Ideal for methanol and FT
- Economy of scale, H₂/CO flexibility as stand alone or with combined reforming

Gas POX

- Ideal for oxo gas and CO production
- Best in class burner lifespan resulting in 1/3 less of downtime compared to the industry benchmark
- Enabler of low emission configurations



engineering-airliquide.com/syngas
syngas@airliquide.com

CONTENTS

What's in issue 355

COVER FEATURE 1

India's 'methanol economy'

COVER FEATURE 2

Industrial grade ammonium nitrate

COVER FEATURE 3

Technology integration

COVER FEATURE 4

Inert catalyst support

NITROGEN+SYNGAS
ISSUE 355
SEPTEMBER-OCTOBER 2018

BCInsight

Southbank House, Black Prince Road
London SE1 7SJ, England

Tel: +44 (0)20 7793 2567

Fax: +44 (0)20 7793 2577

Web: www.bcinsight.com
www.bcinsightsearch.com



Blasting at Kolomela iron ore mine, Australia.

The market for industrial grade AN

Industrial grade ammonium nitrate (IGAN) is the key component of industrial explosives around the world. As such it forms a distinct market segment of the AN industry separate from fertilizer uses, and occupies roughly 22% of all AN demand.

Industrial grade ammonium nitrate (IGAN), also known as low density ammonium nitrate (LDAN), technical ammonium nitrate (TAN) or explosive grade ammonium nitrate (EGAN), as distinct from fertilizer grade ammonium nitrate (FGAN) is a component of most of the world's widely used commercial explosives. About 98% of low density AN goes towards explosives production, and although there are a wide variety of commercial explosives of varying compositions in use around the world, ammonium nitrate is a key component of most of these.

AN as an explosive

The main difference between the fertiliser and explosive grades of AN is, as the name suggests, in the density of the final product. Low density ammonium nitrate used for explosive applications, has a bulk density in the range 0.7-0.8 and is usually made from 96-97% ammonium nitrate solution. By contrast, high density fertiliser grade is usually made from 99.7-99.8% ammonium nitrate solution. The other important characteristic of IGAN as com-

pared to FGAN is its porosity. This is important since the presence of voids enables the prills to absorb and retain fuel oil when they are mixed (as ammonium nitrate/fuel oil, or ANFO) without the mixture becoming unduly wet. These two constituents act as an oxidiser and fuel respectively in the reaction that takes place during detonation.

Industrial explosives are divided into blasting agents and high explosives, with the former by far the largest segment. Blasting agents covers several sub-segments such as emulsions and slurry explosives, but by far the largest sub-segment is ammonium nitrate fuel oil (ANFO). ANFO is the most commonly used industrial explosive, comprising 94% ammonium nitrate and 6% fuel oil. The development of ammonium nitrate as an oxidising agent has been one of the major advances in the development of explosives. It is relatively inert and when pure its sensitivity to impact and shock is very low. However, in the process of combustible impurities its sensitivity grows to the point where it can be detonated with an appropriate booster. Since the 1950s it has come to dominate the industrial explosives market.

ANFO is the primary type of explosive used in open pit mining, particularly in dry mining conditions. However, ANFOs have certain drawbacks, such as lack of water resistance (due to the hygroscopicity of ammonium nitrate), low density and limited concentration of explosive energy (at

such places as the bottom of the bore-hole). The lack of water resistance can be a considerable problem in use, which led in the 1960s to the development of explosive slurries. Initially slurries and water gels were made of aqueous solutions of ammonium nitrate gelled by the addition of cross-linking agents, sensitised by explosives such as TNT, black powder or hexogene, although the critical diameter of such gels was so wide that usage was limited to large bore-holes. Typical slurries contain 30-70% ammonium nitrate and may also include other nitrates (sodium nitrates, calcium nitrate and/or nitrates of organic amines).

A few years later the explosive ingredient was replaced either by very fine aluminium powder or by amine nitrates, but more recently sensitisation has been achieved by an oil-water emulsion, which provides a very stable product. The density, and therefore the sensitivity is provided by the introduction of hollow glass microspheres, or by specific chemical gassing techniques. Like ANFO or the first generation of water gels, emulsions are totally insensitive to shocks or impact, their density can be changed easily as can their sensitivity to detonators. They are manufactured either in cartridge form or more and more, directly at the site of usage, with pump-trucks which deliver the sensitised products directly into the mine-holes.

Emulsion explosives are highly efficient and reliable products when properly formulated and manufactured. They offer a great deal of flexibility via blending with ANFO, and thus allow the manufacture of a range of 'customised' explosive products with a variety of performance and quality characteristics. For example, Heavy ANFO is a combination of ANFO and emulsion and is designed to achieve higher loading densities than available with poured ANFO alone.

Production

In all about 90 million tonnes of ammonium nitrate are manufactured every year (ca 30 million tonnes N). Of this 90 million tonnes, roughly one third; around 20 million tonnes of product is produced as IGAN. Until a few years ago this proportion had been steadily rising, but a growing take-up of AN use as a fertilizer in countries like China has slightly reversed that

trend in recent years, in spite of increasing restrictions on the transport, storage and use of fertilizer grade AN.

Because of the similarity in IGAN and FGAN production, both from an ammonium nitrate liquor, the IGAN industry originally evolved largely as an 'adjunct' to the production of FGAN. However, because of regulatory hurdles in storage and transport of AN, plants tend to be relatively close to areas of end user demand, and as fertilizer and mining areas are often not the same, there has been a gradual polarisation of the industry into dedicated facilities producing one or the other.

Consumption

The main use for commercial explosives is in the mining and quarrying industries. The mining industry uses just over 80% of all industrial explosives, mainly in open cast opening where large amounts of overburden must be cleared from a seam of coal or ore – obviously underground explosions must be handled far more carefully to avoid bringing down tunnels or igniting e.g. coal dust or methane in coal mines. While there are other areas of mining in which explosives are used, including precious metals and rare earths, use of mining explosives in large volumes is mainly confined to the coal, iron ore and copper mining industries, which between them account for 70% of all IGAN consumption. Of these, coal is the largest share, at around two thirds of all mining use.



Coal mining in Australia – coal is still the largest slice of demand for IGAN.

“The mining industry uses just over 80% of all industrial explosives.”

Coal

Once the dominant fuel in the world, worries about its effect on global carbon dioxide output have led to a peaking of production and consumption of coal worldwide in 2012-14. Coal's share of global energy use has fallen from 40% to 27% in just a few years, mainly due to a switch to renewable energy and natural gas in North America and Europe. Even China, which has been the fastest growing demand centre for coal, has begun to slow its use of coal as the Chinese government tries to pivot towards a more service-oriented economy using more sustainable energy sources, and to tackle endemic problems with smog and pollution in its major cities. There has been a crackdown on burning coal near major population centres, and China is aiming to cap its coal consumption at 4.1 billion t/a by 2020 under the current Five Year Plan, and thereafter see a slow decline.

Coal consumption has been on a long-term decline in the US and Europe, in the US spurred by natural gas fracking which has opened up many previously uneconomical natural gas reserves, and in spite of the Trump administration's stated goal of helping the US coal industry, it is hard to imagine bucking such a large scale market trend. For this reason, the location of coal use has sifted this century. In 2000, North American and Europe represented just under half of all coal consumption, and the Asia-Pacific region a similar amount (48%). However, continued rapid industrialisation in Asia has seen this share change dramatically. In 2016 Europe and North America's share of coal consumption was just

22% combined, while Asia-Pacific's had increased to 75%. India's coal consumption continues to rise, from 240 million tonnes of oil equivalent (mtoe) in 2007 to 424 mtoe in 2017, a year which saw a 5% rise in consumption. Southeast Asian countries such as Malaysia, Indonesia and Vietnam are also increasing their coal consumption. For now, however, it looks as though this segment of the explosives market is going to be in long-term decline.

Copper

While use of IGAN in coal mining is mainly in North America, with China and Australia also major users, in South America it is copper mining which is the major consumer. Chile and Peru between them mine about 40% of the world's copper, and consume about half of the copper industry's use of IGAN. In open-pit mining of copper, the primary blasting agent used is ANFO, and this is ideal for the dry conditions encountered in most mines. Water slurries and emulsions are used when wet conditions are encountered. The use of high explosives in the copper mining sector is restricted mainly to development work and underground workings.

Copper demand mushroomed over the past 20 years because of China's rapid industrialisation – copper is mainly used in wiring, electronics, piping, building, construction and transportation, and all of these formed part of China's industrial revolution. Now however, China is facing a demographic shift as the effect of the 'one child policy' makes itself felt in the workforce. The population profile is ageing, with more people retiring and fewer entering the workforce. Most industries have become mature and even suffered from chronic overcapacity, which is only now being tackled. The result has been that China's astronomical growth rates have fallen back to a more 'normal' 6.7%, with India overtaking it. This in turn has led to stagnation in the copper market, which had become built around feeding Chinese demand. Copper production has plateaued since 2015, and while it is forecast to return to growth this year, it is likely to be at a slower rate than before, at around 1.8% per year.

Iron ore

Iron ore is mainly destined for steel production, and again China's industrialisation has generated a massive boost to steel

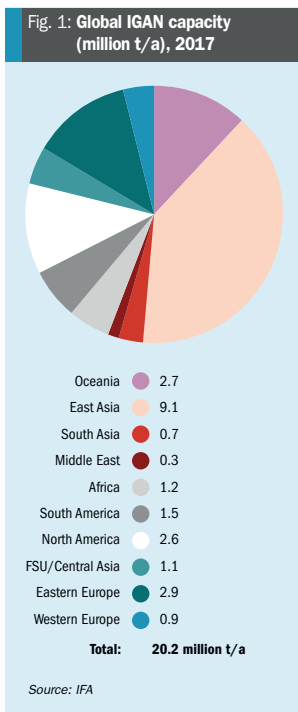

demand over the past two decades. Iron/steel demand is closely correlated with industrial production and GDP growth, and again overcapacity in Chinese steel production and the slowdown in the Chinese economy and its 'rebalancing' towards domestic consumption instead of being the workshop of the world, means that iron ore demand, like that of copper, will be slower than before. However, the situation is not as marked as for copper, with growth rates of 2-3% likely over the next few years.

Iron ore mining is concentrated in three countries; Australia, China and Brazil, which collectively produce about 75% of the world's iron ore. Iron ore mines, generally, have a relatively high waste-to-ore ratio, and in addition very hard rock conditions are encountered in several producing areas, once again requiring mining explosives. The most commonly used explosives are slurries and emulsions, which are adapted for use in large diameter boreholes. ANFO or metallised mixtures (which provide high explosive energy) are also used wherever conditions are dry.

Other uses

Quarrying is an area with increasing demand because of the need for building materials and construction stones, particularly in Europe, Latin America, and the Asia-Pacific region. Construction also uses explosives, for tunnelling and highway construction as a faster and cheaper alternative to drilling through hard rock strata. There is increasing expertise among construction companies with the use of explosives and willingness to use them for such tasks.

In general, however, the mining industry is seeing a retrenchment after two decades of spectacular growth, and while other industrialising countries are taking up the slack left by China, including India, Brazil, the countries of Southeast Asia and even parts of Africa, and while there is growth in smaller areas like quarrying and construction, overall growth in demand for IGAN is likely to be only around 1.2% per year over the period 2017-2022. This is still faster than growth in demand for fertilizer grade AN, however.

New capacity

On a regional basis, as Figure 1 shows, capacity is concentrated in East Asia, but there are also still significant capacities for manufacturing IGAN in Eastern Europe, North America and Oceania – mainly Australia. Overall, the demand for explosives in North America and Europe is relatively mature, and growth likely to be fairly small. However, the Asia-Pacific region currently represents 40% of the market for explosives and continues to see strong growth.

As regulations regarding the transportation of explosives have become more restrictive, so manufacturing of explosives has come to rest close to end use markets. This means that the industry has tended to have to respond to the changes in the regional balance of the mining and quarrying industries. As old, exhausted iron and coal mines close in Europe, so IGAN capacity has rationalised there. In much the same way, capacity has been increasing in Latin America, Africa and especially Australia – 600,000 t/a of new capacity has come on-stream in Australia over the past five years to cope with new demands from the iron and coal mining industries. Africa's IGAN capacity, meanwhile, is forecast to double from 2012-2022, reaching 1.6 million t/a by that time. ■

A MASTERPIECE OF INNOVATION

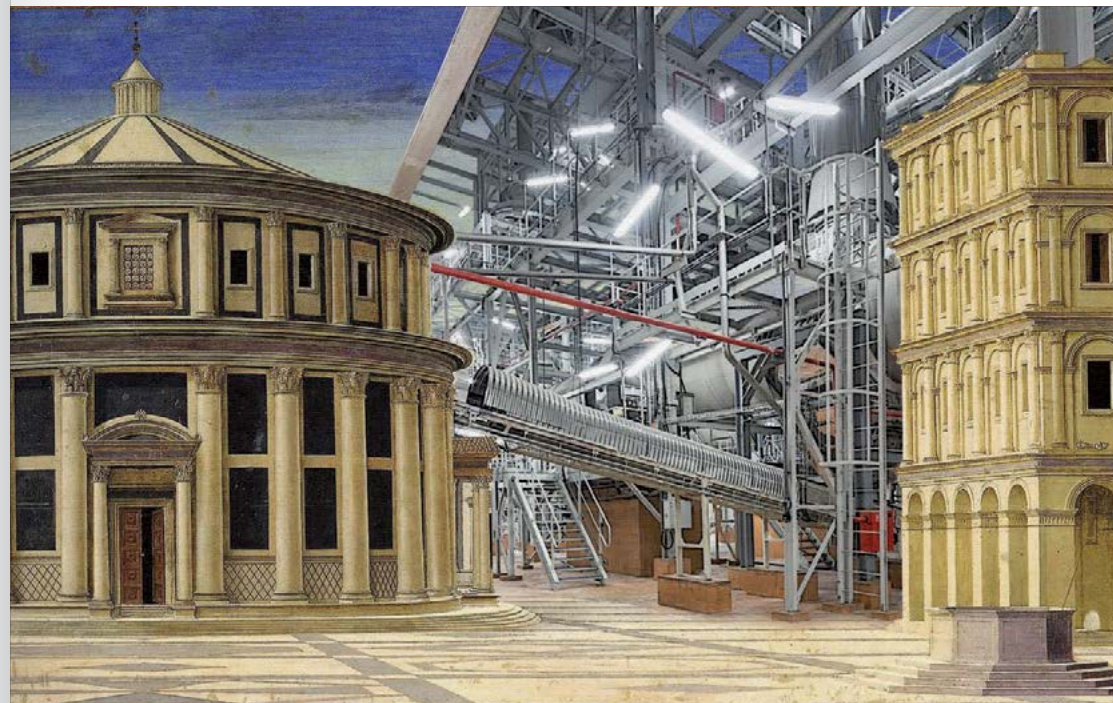

Inspired by Piero della Francesca (attribution), *Ideal City*, 1470, Galleria Nazionale delle Marche, Urbino, ITALY

AN2000: the *ideal* process for AMMONIUM NITRATE

- Capacity up to 2000 MTD
- Wide flexibility of operation
- Low specific consumption rates
- Clean process condensate recovery
- Pipe Reactor Technology

CASALE
casale.ch

Technology integration adding value

Driven by economic cycles, market developments, increasing investment cost and more stringent environmental requirements, ammonia, urea and methanol producers are looking for integrated solutions to provide reliable, cost effective and sustainable production technologies for their products.

Despite urea price fluctuations, market demand for this highly-efficient nitrogen fertilizer remains positive. In recent years there has also been a growing demand for urea-based products, such as urea ammonium nitrate (UAN), AdBlue etc. so, it is not surprising that many mainstream manufacturers of nitrogen fertilizers consider further expansion of their urea production as a priority. The starting point for expansion typically starts with the scale up of the ammonia production, as ammonia is a critical raw material for all nitrogen fertilizers.

For the revamp of existing fertilizer complexes comprising different production units, integration will enhance the benefits of tailored improvements in the design, operation, reliability and performance of the individual units.

The main advantages resulting from process integration are essentially:

- maximum energy efficiency, assuring lowest specific energy consumption through the implementation of more efficient process flow configurations or installation of high efficiency equipment.
- minimum investment cost, avoiding duplication of units and managing common utilities to minimise all equipment sizes.

Ammonia-urea integration

Fundamental integration occurs at the process level and is aimed at optimising the common networks, easily managing recycle streams and combining common sections. For example:

- the steam required for a urea plant can be efficiently generated in an ammonia synthesis loop;
- use of the ammonia process air compressor to provide urea passivation air and urea granulation air;

- recycle of CO₂ compressor interstage condensate to the ammonia plant process condensate stripper;
- use of the ammonia refrigeration section for cooling urea granulation air;
- use of low grade heat from both ammonia and urea plants to produce chilled water in a single unit, to be exploited in both plants;
- the possibility of sending high-pressure ammonia directly from the synthesis loop, to the urea plant, avoiding the need for high-pressure ammonia pumps.

Urea-melamine integration

Producing melamine is an opportunity for a fertilizer complex to generate higher profits and, at the same time, to hedge the seasonal fluctuations of the urea market.

Melamine and urea units can be fully integrated as regards the utilities, raw materials and intermediate streams.

In the overall reaction for the production of melamine, six molecules of urea are required to produce one molecule of

melamine, while six moles of ammonia and three of carbon dioxide are produced as by-products:



The by-products are sent to the urea plant for reprocessing to be converted into valuable urea (Fig. 1).

The profitability of a melamine plant is greatly enhanced if the plant is integrated with an upstream urea plant, where the reprocessing of by-product ammonia and carbon dioxide reduces the net urea consumption to the stoichiometric value of three moles urea per mole melamine.

Methanol-ammonia integration

The concept of methanol-ammonia co-production has a long history and there are many ways of producing both products in a single production asset. The optimum scheme depends, however, on product mix – a scheme optimised around the production of much larger quantities of ammonia than methanol is, for example, unlikely to be suitable for the production

Fig. 1: Melamine reaction with off-gas reprocessing in urea plant

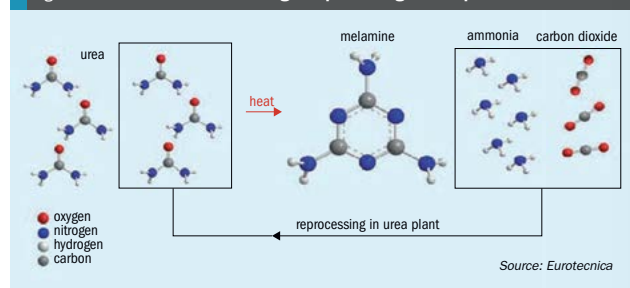

Fig. 2: Conventional crop protection spraying equipment.

of much larger quantities of methanol than ammonia.

When compared to dedicated ammonia and methanol plants, co-production schemes can suffer from a degree of compromise because the incorporation of both methanol and ammonia production capability into a single flowsheet can mean that the process conditions for both are suboptimal. If present, these compromises can lead to inefficiency and/or risks to product quality.

Commercial factors also come into play in that ammonia and methanol market cycles are not always in alignment which means that it is often necessary to vary product mix and, sometimes, to be able to produce one product without being forced to make the other.

Once methanol and ammonia are available in the same location, other opportunities arise such as the manufacture of urea formaldehyde concentrate which is commonly used in urea granulation plants. Amines are another potential opportunity.

Urea-UAN integration

UAN, a liquid fertilizer containing typically 32% nitrogen, has gained more and more interest over the years due to its ease of handling and efficient use. While for the application of ammonia, urea, NPK, etc. dedicated equipment is required, UAN can be applied using conventional crop protection spraying equipment (Fig. 2) or stream bars. It can even be applied in combination with crop protection products, not only saving on additional labour, but also aiming for synergistic effects between liquid fertilizers and crop protection products.

As UAN is a liquid product, other liquid products can be easily incorporated, providing the required nutrients such as phosphate, potash and sulphur, or adding nitrification inhibitors.

Transport of UAN is easy and non-restricted, unlike ammonia transport which

is increasingly restricted. This supports the transition from ammonia fertilisation to UAN. Additionally UAN can easily be stored in tanks made from normal carbon steel, presuming corrosion inhibitors are added. Prices for UAN are generally higher than for urea, corrected for their nitrogen content. Including the relative low cost of investment, the margin per tonne of nitrogen for UAN is higher than for urea.

UAN can be manufactured from dissolved solid urea and ammonium nitrate. However, it is far more economical to produce UAN in an integrated production plant. The major advantage of such an integrated UAN plant is that the need for expensive solids formation and handling is not required, the end product remains in liquid form and can be easily transported and stored in tanks. This allows for the abolishment of an expensive finishing section.

Whereas urea and/or AN can be dissolved in water relatively easily, the maximum concentration is limited. At lower temperatures both products would normally crystallise and phase separation would occur. UAN, being a mix of urea and AN solution however, still has a very high solubility at lower temperatures (Fig. 3). Although 32% UAN contains only

relatively small amounts of water (about 20%), it is a complete transparent liquid even below 0°C.

In very cold conditions, UAN can be easily diluted with water to further avoid crystallisation. In France UAN is typically used at 30% N, whereas in Northern Germany the use of 28% N is common.

Stamicarbon urea technology integration

Stamicarbon, the innovation and license company of Maire Tecnimont Group has more than 70 years of experience in licensing in the fertilizer industry. It has built up a long track record of more than 260 realised urea projects, but its field of expertise extends beyond urea with know-how on melamine integration and nitric acid technology to produce nitrate fertilizers. With the latter comes the potential to also produce UAN liquid fertilizer.

Stamicarbon's integrated production processes are designed to achieve best in class performance, low investment, and low operation cost performance in new and existing plants. This goes hand in hand with low emissions, low energy consumption, recycling of waste streams, etc., providing a sustainable position for the future.

Fig. 3: AN-urea-water phase diagram

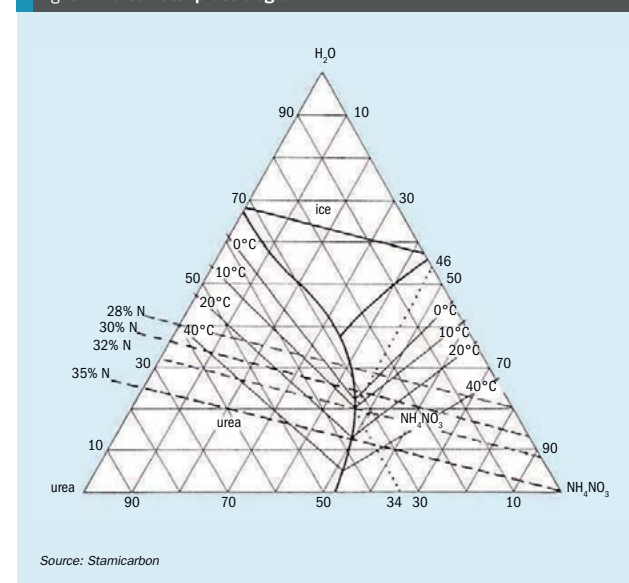

Source: Stamicarbon

CONTENTS

What's in issue 355

COVER FEATURE 1

India's 'methanol economy'

COVER FEATURE 2

Industrial grade ammonium nitrate

COVER FEATURE 3

Technology integration

COVER FEATURE 4

Inert catalyst support

NITROGEN+SYNGAS
ISSUE 355
SEPTEMBER-OCTOBER 2018

BCInsight

Southbank House, Black Prince Road
London SE1 7SJ, England
Tel: +44 (0)20 7793 2567
Fax: +44 (0)20 7793 2577
Web: www.bcinsight.com
www.bcinsightsearch.com

Fig. 4: Urea-melamine coupling with added new MP section

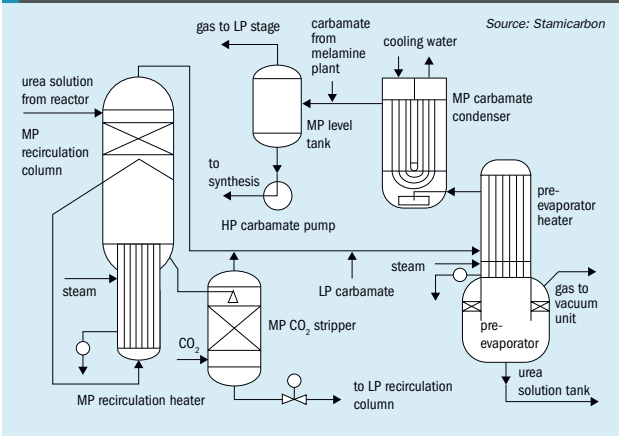

Stamicarbon offers two sophisticated integration designs:

- urea-melamine coupling technology;
- fully integrated UAN technology.

Stamicarbon urea-melamine integration

Stamicarbon has experience and well proven technology to couple urea and melamine plants. The process can be used for grassroot plants, as well as for a revamp concept for most urea plant technologies.

The main consequence of coupling urea and melamine plants in a revamp concept is the introduction of a medium-pressure (MP) stage. By adding a medium-pressure section to the existing plant it is possible to increase urea plant capacity by 20% and if additional modifications are made in the downstream of the synthesis section capacity increases of up to 50% can be achieved.

The MP stage is fed with the liquid solution coming out of the reactor. The existing line downstream of the stripper has almost the same load after the revamp compared to the existing situation. This results in a minimum amount of modifications in the synthesis section. In this concept the stripper and the reactor are operated at their maximum load.

In the medium-pressure stage, the solution is expanded to a pressure of about 18 bar and is fed to a new recirculation column. In a heat exchanger connected to the column the liquid is heated up to a temperature of about 160°C. The liquid leaving this column is directed to a stripping

column, where part of the CO₂ is contacted with descending liquid counter currently. The liquid from this medium-pressure stripper is sent to the existing rectifying column, see Fig. 4.

All gas flows from the MP recirculation and the MP CO₂ stripper column are combined. In order to condense these vapours, they are mixed with the low-pressure carbamate stream coming from the existing low-pressure carbamate condenser. This combined stream is partly condensed in the pre-evaporator heater. Further condensation takes place in the medium-pressure carbamate condenser.

The recycle carbamate flow from the melamine plant is also fed to the medium-pressure carbamate condenser. The condensed carbamate liquid leaving the MP carbamate condenser is pressurised to the synthesis pressure by the existing high pressure carbamate pumps.

The pressurised carbamate is distributed over the HP scrubber and the HP carbamate condenser. The distribution is controlled in such a way that the existing liquid load of the HP scrubber is not exceeded. The remaining part is sent to the HP carbamate condenser.

The main advantages of coupling a melamine plant to an existing urea plant are:

- Less ammonia and carbon dioxide are required to produce the same amount of urea, due to the addition of carbamate from the melamine plant. The additional carbamate stream coming from the melamine plant, offloads the existing carbon dioxide compressor and the ammonia pumps.
- The stripper is unloaded by the introduction of the new MP section. Because of this the risk of flooding is reduced at the stripper.
- Only limited modifications are required in the existing plant. There is no need to install a new high pressure equipment in order to increase the capacity with this concept, only if a small additional reaction volume is necessary.
- The additional MP section can be decoupled if necessary and the plant can be operated with its original concept again.

Stamicarbon has coupled urea and melamine processes in a few plants by introducing the MP section. The capacity of a plant in China was increased from 1,700 to 2,300 t/d, while the capacity of a plant in Egypt was successfully increased from 1,925 to 2,250 t/d. There is also an ongoing project for a plant in the US to increase the capacity from 1,750 to 2,160 t/d.

Stamicarbon fully integrated UAN technology

The process flow diagram in Fig. 5 shows Stamicarbon's fully integrated UAN plant.

Fig. 5: Stamicarbon's fully integrated UAN plant

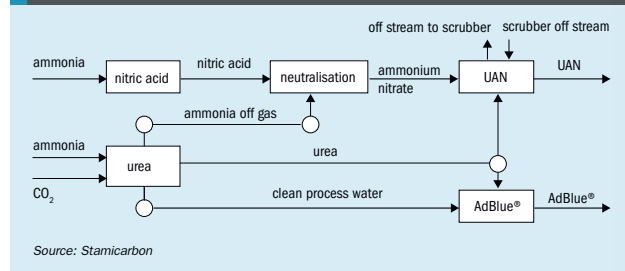

In the first section of the plant, nitric acid is produced by the absorption of nitrogen dioxide (NO₂) in water. Nitrogen dioxide is formed by the oxidation of nitrogen monoxide (NO), while nitrogen monoxide is produced by oxidising of ammonia on Pt/Rh gauzes in an exothermic reaction. The required oxygen for the oxidation of the ammonia is supplied by adding air to the catalytic combustion chamber of the ammonia burner.

The overhead vapour of the absorption/oxidation column still contains traces of NOx and N₂O. To remove these to an acceptable level, the tail gas is heated and introduced into a tertiary abatement system. In this system two catalyst beds are installed where subsequently N₂O and NOx are converted to water and nitrogen. To convert the NOx, ammonia is supplied between the two beds. The still pressurised tail gas is expanded over the tail gas expander and cooled before it is relieved to the atmosphere.

In the second section urea is produced by reacting liquid ammonia and supercritical carbon dioxide. In the first reaction carbon dioxide and ammonia are converted into ammonium carbamate. This reaction is fast and exothermic. In the second reaction, which is slow and endothermic, the ammonium carbamate dehydrates to produce urea and water. The urea solution leaving the low pressure recirculation section is collected in the urea solution tank. This urea solution is pumped to an evaporator that is operated at sub-atmospheric pressure. The process condensate leaving the vacuum condenser is collected in an ammonium water tank. The non-condensed vapour is conveyed by a steam ejector to an atmospheric absorber. Here the remaining ammonia is neutralised to form ammonium nitrate by using acidic condensate from the UAN section. The concentrated urea solution leaving the evaporator is pumped to the urea/ammonium nitrate mixer in the UAN process section. At this stage the urea solution can also be used for DEF production, making it possible to switch between UAN and DEF production in a flexible manner.

The third AN process section comprises a neutraliser, an ammonium nitrate storage tank, and off-gas purification equipment. The neutraliser consists of a U-type combination of a circulation tube and a mixing tube with a separator. Ammonia-containing gases from the urea plant together with ammonia from battery limits

are fed into the bottom of the mixing tube. Nitric acid is introduced somewhat lower in the circulation tube. The two components react exothermically to form ammonium nitrate.

The presence of liquid in the circulation tube and of the gas-liquid mixture in the mixing tube causes the fluid to circulate. The heat of reaction is used for the evaporation of water present in the nitric acid supply. The pH of the solution is controlled by addition of nitric acid. The gas and liquid phases are separated in the separator, the liquid being sent to the ammonium nitrate storage tank. The additional ammonia supply to the neutraliser next to the ammonia in the off-gas from the urea plant, controls the required ammonium nitrate/urea ratio in the UAN end-product.

In the fourth urea/ammonium nitrate section the following substances are mixed to produce the required UAN concentration of between 28% and 32% nitrogen:

- urea solution, still containing some NH₃;
- ammonium nitrate solution;
- nitric acid;
- potential liquid effluent from the dust purification scrubber and off-gases from the UAN section can be sent to the scrubber to avoid emissions.

Here again the heat of reaction is utilised to increase the temperature and to evaporate water. The ammonium nitrate to urea ratio is controlled at about 1.35. The pH is controlled at 5 to 6 by means of adding some nitric acid. The resultant UAN solution is either stored or pumped to battery limits.

To avoid corrosion issues it is advised to add a corrosion inhibitor before the product is stored, awaiting the final application on the field by the farmer. Stamicarbon offers a proprietary corrosion inhibitor for this, ADVANCE PROTECT™, which provides effective protection of equipment, tanks, and pipes at low dosages. Furthermore it has de-foaming characteristics and is biodegradable.

Stamicarbon's integrated once-through urea production technology has a number of advantages. The urea section in the integrated plant may operate at an ammonia efficiency which is way below 100% because the unconverted ammonia leaving the urea section is converted into ammonium nitrate in the downstream neutralisation section of the integrated plant. This gives the opportunity to design

a once-through urea section without a low pressure or medium-pressure carbamate recycle. This saves a recycle concentration section, cuts back on the investment for costly high pressure (recycle) pumps and reduces the relatively high electricity consumption of these pumps. The energy consumption can be even lower if multiple use can be made of the energy from the steam used in the process, which is generated in the nitric acid part of the plant.

The Stamicarbon integrated UAN design allows for the complete recycling of waste streams from the urea granulation section, where acidic scrubbing with nitric acid results in urea-AN waste streams. These can be fully recycled into the UAN process.

The plant can also be designed in such a way that DEF (diesel exhaust fluid)/AdBlue® can be produced. As the nitrogen concentration of DEF is lower than that of regular urea solution, clean process water produced in the integrated urea section needs to be added to bring the product up to spec.

NIIK urea-UAN integration project

Besides the global trend for increasing the capacity of large-scale urea plants, there is also sometimes a need to increase production of a small-scale urea unit or a urea solution plant for further production of UAN. NIIK, a leading Russian engineering and technology company that provides comprehensive services for urea plants, offers its own urea technology URECON 2006® to meet this requirement. URECON 2006® makes it possible to significantly reduce investment costs and shorten the project implementation period via the use of existing or stand-by process equipment.

NIIK is currently in the final stages of such a project for the construction of a urea solution plant at one of the largest Russian companies. The plant is designed to produce 72% urea solution, which will then be converted into urea ammonium nitrate (UAN). That means there is no need to install an evaporation section, granulation unit or wastewater treatment section. In addition, low energy consumption, low air emissions and wastes make the process environmentally friendly.

The Russian fertilizer producer already has ammonia and urea units at the site and part of the produced urea solution is transferred to the UAN plant.

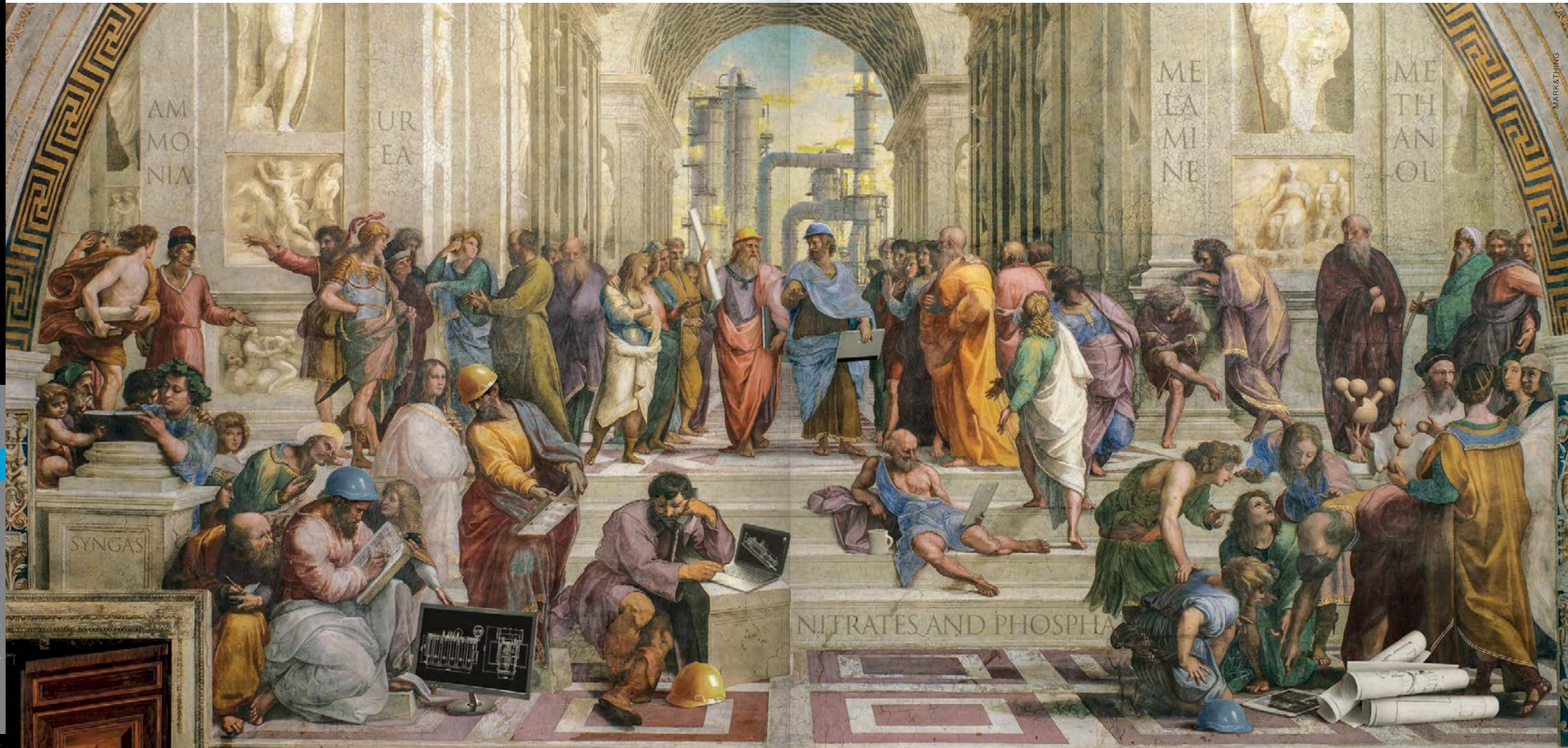

Inspired by
The School of Athens, Raffaello Sanzio 1509-1511
Vatican Museums. Photo Scala Archives

AMMONIA
NITRATES & PHOSPHATES
UREA
MELAMINE
METHANOL
SYNGAS

A FULL RANGE OF TECHNOLOGIES AND SERVICES

 **CASALE**
casale.ch

CONTENTS

What's in issue 355

COVER FEATURE 1

India's 'methanol economy'

COVER FEATURE 2

Industrial grade ammonium nitrate

COVER FEATURE 3

Technology integration

COVER FEATURE 4

Inert catalyst support

NITROGEN+SYNGAS
ISSUE 355
SEPTEMBER-OCTOBER 2018

BCInsight

Southbank House, Black Prince Road
London SE1 7SJ, England
Tel: +44 (0)20 7793 2567
Fax: +44 (0)20 7793 2577
Web: www.bcinsight.com
www.bcinsightsearch.com

Fig. 6: Existing urea production

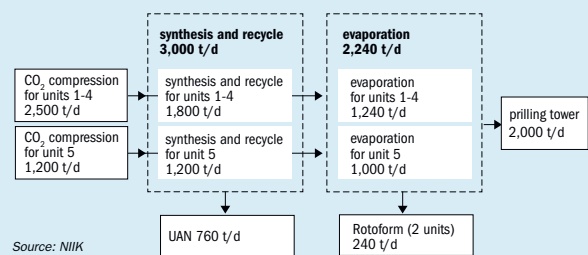

Fig. 7: Urea production after enhancement

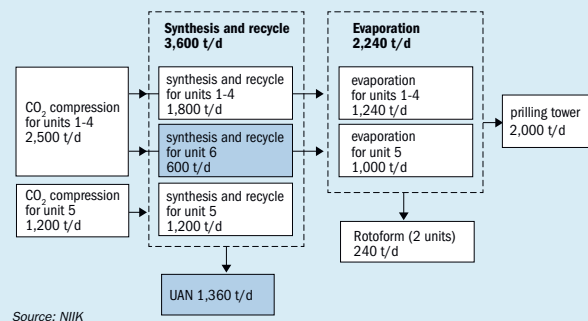

Fig. 8: URECON 2006® urea solution unit

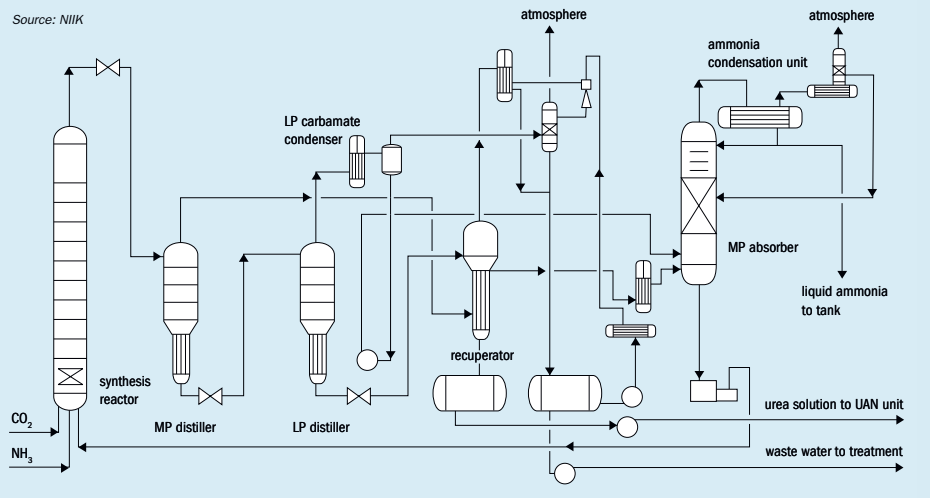

Fig. 6 shows a block flow diagram of the existing urea production.

Upon commissioning of a new ammonia production unit the company decided to expand the production of urea solution in order to increase its UAN output. NIIK suggested the installation of a small-scale urea solution plant using the existing equipment, for instance the CO₂ compression unit and urea synthesis reactor, in order to significantly reduce building costs and project execution time.

Fig. 7 shows a block flow diagram of the urea plant after expansion.

In the long term the urea production can be enhanced via construction of an evaporation section and prilling or granulation unit for the commercial production of a solid form of urea. In the meantime, the construction of the urea solution unit enables the company to increase UAN production and make additional profit.

NIIK's URECON 2006® technology was selected as the best option for the urea solution unit.

The process flow diagram in Fig. 8 shows the only high-pressure vessel, i.e. the synthesis reactor. It should be noted, that a stand-by vessel from the existing urea plant is used as the reactor. In order to increase its efficiency the reactor is additionally equipped with a special set of internal devices (SID) by NIIK, which includes the following:

Fig. 9: Efficiency upgrading of the urea synthesis reactor

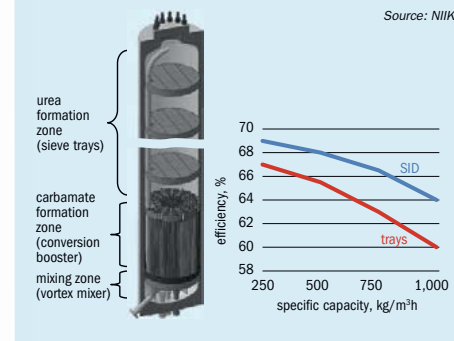

- a vortex mixer;
- a conversion booster;
- ten sieve trays.

With installation of the SID (Fig. 9) very high reactor performance is achieved while retaining a comfortable conversion rate. The existing stand-by reactor with a volume of 31 m³ can be used with greater benefit in the urea solution plant with capacity of 600 t/d (equivalent to 100% urea).

The urea solution from the reactor is distilled in two stages (medium pressure stage and low pressure stage) with recycle of unreacted ammonia and CO₂. The urea solution then passes to the pre-evaporation phase where it is concentrated to minimum 72% by means of the heat from the medium pressure distillation gases. A small amount of resulting process condensate is transferred to the new waste-water treatment unit currently under construction and designed for several plants.

The urea solution distillation is performed in the distillers represented by special vessels containing a tray-type rectifying column and film-type heater. The combination of multiple processes in a single vessel increases the efficiency, while the space required for equipment and number of pipelines is reduced. Corrosion of equipment also decreased.

One of the most important distinguishing features of the proposed process flow diagram compared to a traditional total liquid recycle process is that the medium pressure condenser unit uses a vertically-mounted condenser with U-tubes, where the solution is circulating outside the tubes. Thus, the condenser is cooled by

Fig. 10: Distribution of CO₂ compressors by urea plants

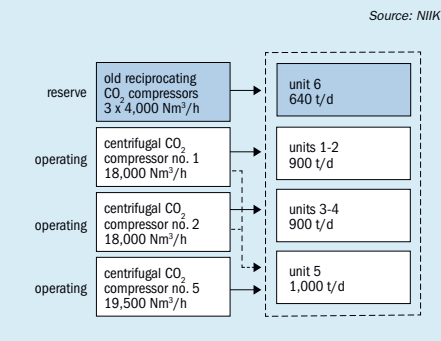

water circulating in a separate closed cooling loop. The temperature of this cooling water can be adjusted as required. As a result, the condenser efficiency increases and the potential for carbamate solution crystallisation outside of the tubes is practically eliminated.

In addition, part of the process heat (heat from the medium pressure ammonium carbamate formation) is utilised for the pre-evaporation of urea solution up to the minimum concentration of 72%. The heat recuperation is carried out in a special vessel, the heat recuperator, which performs functions of the film-type evaporator and medium pressure carbamate condenser.

Almost all the elements of the process flow diagram have been tested many times in other urea revamping projects with total liquid recycle process technology and proved their high efficiency.

For the CO₂ compression unit, in this particular case NIIK used the reserve capacity of the existing compressor equipment (Fig. 10). These reserves were revealed earlier after the partial replacement of old reciprocating compressors by new centrifugal compressors of greater capacity.

If such reserves were not available, a new CO₂ compression unit would have been required. This issue can be resolved in different ways depending on the existing configuration of the CO₂ compression unit, its current physical condition and available financing.

The environmental aspects of the project also merits special attention. Due to the small volume of waste water and efficient gas scrubbing system the unit meets the most stringent environmental standards.

The expected performance indicators of the urea solution plant are shown in the Table 1.

The main advantages of the proposed urea solution plant design are the following:

- Low investment costs and significant reduction of the project execution time due to re-use of the existing CO₂ compressor equipment and synthesis reactor, which are usually top-priced and take much time for manufacturing and procurement. Besides that, there is no need to provide an additional infrastructure for interconnection of the new plant, because it already exists at site.

Table 1: Basic parameters of the urea solution plant

Parameter	Value
Capacity equivalent to 100% urea, t/d	450-700
Steam consumption for industrial requirements, Gcal/t	0.7
Power consumption for industrial requirements *	50
Cooling water consumption*	90
Composition of urea solution, wt-%	
Urea	≥72
Ammonia	≤0.3

* Consumption of utilities for CO₂ compression is not included Source: NIIK

- Staff training is not required as the process of the new plant is similar to the existing units on stream. Thus, the breaking-in period will be also notably reduced.
- Good efficiency and space saving design of the new plant are guaranteed by NIIK's best practices in operating and revamps of urea units all over the world.
- The multi-unit process technology provides great flexibility. Depending on market conditions, there is the opportunity to produce different products: not only solid urea, but also UAN, AdBlue etc.

Johnson Matthey integrated process design

As a leader in catalyst and process technology development for the ammonia and methanol industries, Johnson Matthey (JM) offers a range of ammonia-methanol co-production technologies, to accommodate any product mix.

Ammonia capacity much less than methanol capacity

When the ammonia capacity is much less than the methanol capacity, the economics of the methanol plant dominate and it is advantageous to base a co-production scheme around a methanol flowsheet.

A typical methane steam reformer based methanol plant with natural gas feed and no CO₂ addition will produce about 40% more hydrogen than can react with the available CO and CO₂ to produce methanol. If there is an on-site use for hydrogen, or a connection to a hydrogen pipeline, pure hydrogen can be recovered from the purge gas, most commonly by a pressure swing adsorption (PSA) system. However, in many cases the excess will be purged from the

synthesis loop and used as reformer fuel.

The surplus hydrogen can also be used in an ammonia co-production loop, in which case an ammonia capacity up to about 30% of the methanol capacity is possible.

The only compromise that needs to be made in methanol plant design is to ensure that there is an excess of hydrogen. In most cases, this means a flowsheet with a single steam reformer. Once this decision has been made, the methanol plant can be designed and optimised as a stand-alone unit with little or no regard to the presence of the ammonia loop (Fig. 11). In terms of the ammonia plant, the methanol loop purge which passes via a hydrogen recovery unit to the ammonia plant, and a small purge stream from the ammonia loop which may be used as fuel on the methanol reformer (but which is not required in order to operate the methanol plant). The purges are scrubbed using established technology for ammonia and methanol plants. In the former case, the liquor is distilled to produce pure ammonia. In the latter case, the methanol liquor is processed through the topping and refining columns to produce pure methanol.

The net result is a standard and efficient methanol flowsheet which can operate independently of a high efficiency ammonia synthesis loop and which, being separate, cannot lead to ammonia ingress into the methanol synthesis loop and hence to trimethylamine (TMA) contamination of the product methanol.

Key features of this scheme are:

- high flexibility;
- the ammonia production rate can be increased, and the methanol production rate decreased by sending syngas via the hydrogen recovery unit to the ammonia loop;

- the ammonia production rate can be reduced without affecting the methanol production rate by using methanol purge gas as fuel;
- methanol can be made without making ammonia;
- good efficiency;
- significant reduction in capex compared to independent plants;
- no requirement for an air separation unit (ASU).

Ammonia capacity comparable to methanol capacity

As the requirement for ammonia increases, an extra source of hydrogen needs to be found.

Common reformer: One option is to install a larger (or a second) steam reformer and use the extra hydrogen to augment that from the methanol reformer (but which is not required in order to operate the methanol plant). Depending on site-specific economics, the reformed gases can also be subjected to one or more stages of water gas shift, wet CO₂ removal and methanation.

Features of the process are:

- fewer equipment items than for separate plants;
- the requirement for an ASU;
- the methanol plant can operate independently of the ammonia plant;
- depending on the relative ammonia and methanol plant capacities, it may or may not be economic to produce ammonia without making methanol.

Integrated flowsheet: Another option, which is the subject of a patent application, is to use an air fired autothermal reformer (ATR) in parallel with the steam reformer. This allows the methane contained in the methanol loop purge gas to be upgraded to hydrogen/ammonia value rather than degraded to fuel value. Additional feed natural gas is fed to the ATR as

Fig. 11: Connections between methanol plant and ammonia loop

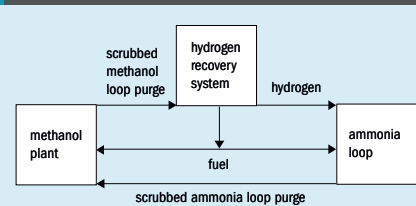

Source: Johnson Matthey

Fig. 12: Single reformer feeding both ammonia and methanol loops

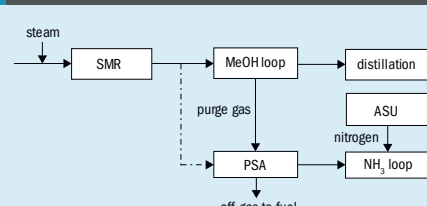

Source: Johnson Matthey

Fig. 13: Johnson Matthey integrated flowsheet

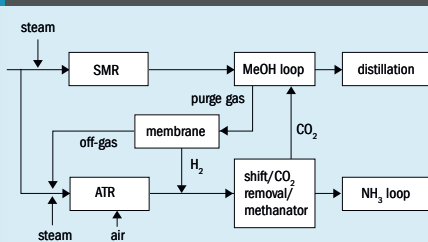

Source: Johnson Matthey

required to achieve the requisite ammonia production rate (Fig. 13).

The main advantages are:

- high efficiency;
- reduced equipment count compared to the stand-alone option;
- no requirement for an ASU;
- considerable freedom to flex nameplate ammonia and methanol capacity;
- considerable freedom to flex instantaneous product mix.

Separate trains: Stand-alone ammonia and methanol plants are by far the most flexible configuration. Each can be designed without compromise, thereby ensuring optimal efficiency. In addition, there are no constraints whatsoever on product split or operating rate.

As before, surplus hydrogen from the methanol plant can be sent to the ammonia plant to increase ammonia make.

In addition, by-product CO₂ from the ammonia plant can be exported to the

methanol plant either as reformer feedstock or as make up to the methanol loop thereby increasing methanol make.

As a consequence, overall profitability can be improved by preferentially sending hydrogen to the ammonia plant when ammonia economics are better than methanol economics; and preferentially sending CO₂ to the methanol ammonia plant when methanol economics are favourable (Fig. 14).

Key features of this process are therefore:

- maximum possible flexibility;
- high efficiency;
- no requirement for an ASU.

Ammonia capacity much larger than methanol capacity

When the ammonia capacity is much larger than the methanol capacity, the economics of the ammonia plant dominate, and it is advantageous to base co-production around an ammonia plant flowsheet.

Fig. 14: Separate trains

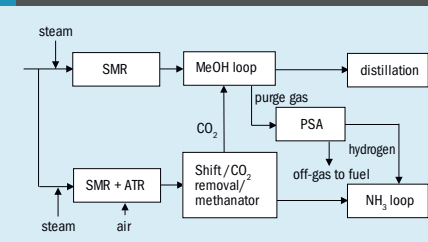

Source: Johnson Matthey

Fig. 15: Saturator-desaturator scheme

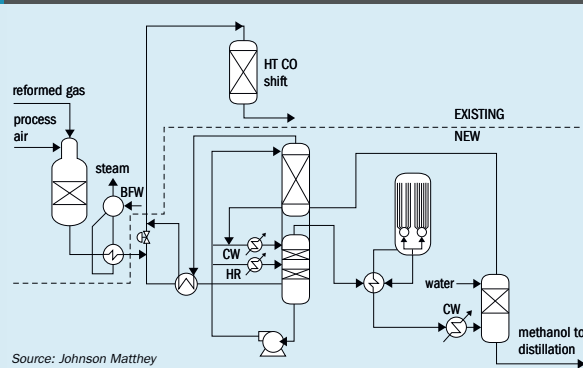

Source: Johnson Matthey

JM's saturator/desaturator scheme consists of a once through methanol reactor upstream of the ammonia plant high temperature shift (HTS) (Fig. 15).

Key features of the scheme are:

- simplicity;
- no requirement for a compressor for methanol capacities up to about 30% of ammonia capacity;
- easy to reduce methanol production rate (and increase ammonia production rate);
- ammonia can be made without making methanol.

Johnson Matthey's FORMOX integrated UFC process

In addition to being a leader in catalyst and process technology development for the ammonia and methanol industries; JM is also a leader in the formaldehyde industry. The production and use of these three chemicals is linked. Carbon dioxide, a by-product of the synthesis gas generation process for ammonia manufacture, can be usefully combined with product ammonia to synthesise urea, an important fertiliser and chemical product. Solid urea is manufactured as prills or granules and formaldehyde (in the form of urea-formaldehyde concentrate or UFC) is used to condition granular, and sometimes prilled, urea. One of the most commonly used grades of UFC is UFC-85, a mixture of 60% formaldehyde, 25% urea and the balance water. Formaldehyde is produced from the oxidation of methanol, which in turn is produced from synthesis gas.

Generally, the formaldehyde additive required for urea conditioning is purchased from a third party as the small quantities required for an individual ammonia/urea plant are below the economic limit that would justify investment in a stand-alone

Fig. 16: JM's FORMOX integrated UFC process

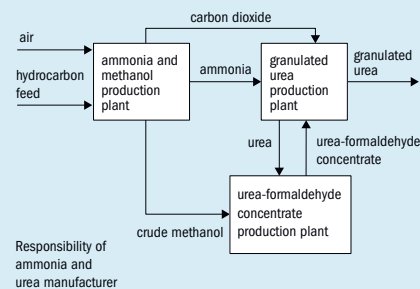

Source: Johnson Matthey

Fig. 17: UFC plant flowsheet

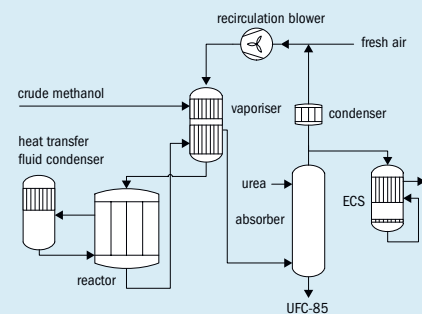

Source: Johnson Matthey

formaldehyde plant along with the associated methanol plant.

As a result, urea producers tend to purchase UFC-85 from third parties whose cost structure is based on the purchase (or opportunity cost) of methanol at market price which is normally at a considerable premium to the cost of the raw materials used to synthesise the methanol. The cost of the UFC-85 is further increased due to transportation costs, the need to cover supplier overheads and return on investment criteria.

Using the knowledge and experience available across JM, a novel scheme (Fig. 16), which is the subject of patent applications, has been developed whereby the ammonia, methanol and UFC 85 production plants have been combined to provide reliability of supply as well as capital and operating cost savings.

Methanol synthesis

JM's integrated flowsheet uses the residual carbon oxides downstream of carbon dioxide removal, which would otherwise be removed by methanation, to produce methanol.

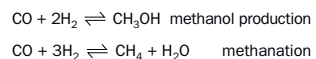

As shown by the equations above, the production of methanol from carbon monoxide consumes less hydrogen per mole of carbon oxide removed than is the case with methanation. Therefore, production of methanol leads to an increase in the amount of hydrogen that is available for ammonia synthesis. In addition, the meth-

ane content of the make-up gas is lower which allows more efficient operation of the synthesis loop.

As a result, methanol is synthesised whilst improving both ammonia plant efficiency and ammonia plant throughput. Further savings may be made through the use of a crude methanol feedstock for formaldehyde/UFC production rather than the high purity methanol that is commonly used.

Urea formaldehyde concentrate (UFC-85) production

Production of formaldehyde and UFC uses well established technologies. JM's FORMOX™ technology employs mixed oxide catalyst due to its superior yield, high steam production and because it makes it possible to produce UFC-85 directly in the same plant.

The main principle is to partially oxidise methanol in the presence of air to form formaldehyde and water. The gas mixture of formaldehyde, water and air is separated in an absorption column in which water is condensed and the formaldehyde is absorbed into the water. UFC is produced when formaldehyde is absorbed into a urea solution which is fed to the column. The oxidation process consumes oxygen; hence oxygen needs to be provided to the process and oxygen lean gas has to be removed. The oxygen lean gas contains traces of formaldehyde, methanol and carbon monoxide and is passed over a noble metal catalyst incinerator (emission control system or ECS) in which trace impurities are converted to carbon dioxide and water (Fig. 17).

Capital and operating costs

JM's FORMOX integrated UFC process can be installed at modest capital cost and allows substantial savings equivalent to the majority of an operator's annual expenditure on UFC85.

FORMOX formaldehyde and UFC technology

In addition to the integrated UFC process, JM also offers FORMOX technology for larger scale formaldehyde and/or UFC production.

JM supplies a comprehensive range of standard plant sizes that are designed to cover a very broad range of capacities. The idea is to offer formaldehyde producers the greatest possible flexibility in choice of operating point. The plants and catalyst are optimised to give best performance at the capacity you will need

JM's FS and FT plants cover a capacity range extending from 70 t/d to nearly 1,100 t/d of formaldehyde (expressed as 37% HCHO); or 43 to 660 t/d of UFC85 in one production unit

Expandable versions (FE) can also be installed for a producer who sees good growth potential but wishes to keep the initial investment to a minimum.

Moreover, when set up for UFC production, a FORMOX formaldehyde plant can produce either UFC (up to 85%) or formaldehyde (up to 57%) in campaigns.

Methylamines

Methylamines are important chemical intermediates used in many specialist applications. Methylamines comprise the primary amine, monomethylamine (MMA), the secondary amine, dimethylamine



Industrial Solutions for the fertilizer industry

Get fit for the future.

If you need a highly experienced and reliable partner for advanced fertilizer technologies and turnkey plants, look no further than thyssenkrupp Industrial Solutions. Besides our broad portfolio of fertilizer technologies (mainly uhde®) for the production of ammonia, urea, nitric acid and ammonium nitrate, our expertise in phosphate fertilizers, ammonium sulfate granulation, urea-ES (Enhanced Sulfur) and slow-release urea technologies can help make your fertilizer plant fit for future. And for our new technologies, whether it's AdWinMethanol® and AdWinCombined™, the most efficient methanol technology or our 'green portfolio' of hydrogen, methanol and ammonia based on our own H₂ electrolysis technology – advanced engineering is what thyssenkrupp stands for. www.thyssenkrupp-industrial-solutions.com



thyssenkrupp

engineering.tomorrow.together.

CONTENTS

What's in issue 355

COVER FEATURE 1

India's 'methanol economy'

COVER FEATURE 2

Industrial grade ammonium nitrate

COVER FEATURE 3

Technology integration

COVER FEATURE 4

Inert catalyst support

NITROGEN+SYNGAS
ISSUE 355
 SEPTEMBER-OCTOBER 2018

BCInsight

Southbank House, Black Prince Road
 London SE1 7SJ, England
 Tel: +44 (0)20 7793 2567
 Fax: +44 (0)20 7793 2577
 Web: www.bcinsight.com
www.bcinsightsearch.com

Fig. 18: Methylamines chemistry

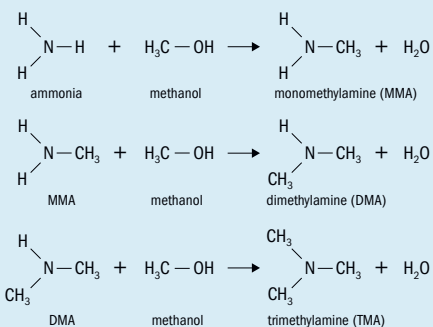

Source: Johnson Matthey

(DMA), and the tertiary amine, trimethylamine (TMA) (Fig. 18).

Methylamines have a large and varying range of uses (Fig. 19). MMA is the feedstock for n-methylpyrrolidone (NMP) as well as for carbamate insecticides and surfactants. MMA is also used in the manufacture of methyldiethanolamine (MDEA), which is used in gas treatment. DMA is primarily used for manufacturing dimethylformamide (DMF) although it is also used to make dimethylacetamide (DMAC), fatty amines, and detergents such as lauryl dimethylamine. The major use of TMA is in the manufacture of the animal feed supplement, choline chloride (ChCl).

DAVY methylamines process

Methylamines are produced by reacting ammonia with methanol at an elevated temperature and pressure in the presence of a

silica alumina catalyst. Most of the exothermic reaction heat is used in the feed heat recovery system. A mixture of three amines is formed, MMA, DMA, TMA, which are purified to high quality in the distillation system (Fig. 20). The correct selection of feed ratio and recycling of amines produces the desired product mix in a highly flexible manner. As a result, the plant can be designed to produce only monomethylamine (MMA), only dimethylamine (DMA), only trimethylamine (TMA) or any combination of the three to suit the market requirement.

Anhydrous amines can be diluted for atmospheric storage and easy transportation via drums or ISO containers. Aqueous amine solutions are produced from the anhydrous amines by diluting them to 30 to 40 wt-% with water.

JM also offers processes for NMP, DMF and ChCl.

Fig. 20: Methylamines process

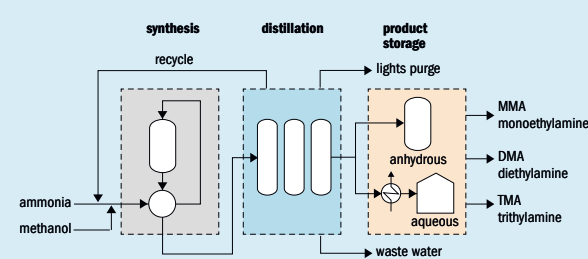

Source: Johnson Matthey

Fig. 19: Methylamines and derivatives

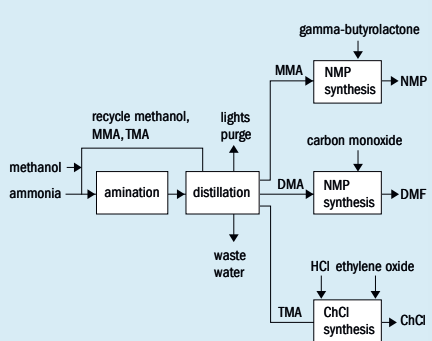

Source: Johnson Matthey

Key features of the DAVY™ methylamines process are as follows:

- the world's most extensively licensed process technology for methylamines;
- a proven and reliable design that produces world-class product qualities;
- a highly efficient, high activity, and low by-product catalyst;
- a highly flexible plant can be designed and operated to give the optimum selection of product between the primary, secondary, and tertiary amine products and can be adjusted online to match future market requirements;
- optimised heat integration for low capital and operating costs;
- designed for low environmental impact including numerous features to prevent atmospheric emissions;
- ongoing technology development and technology support.

Euromel® melamine/urea integrated complexes

Producing Euromel®, a top quality melamine whose average selling price is four to six times the feedstock price, means immediate access within a global network of highly reputed producers and reduces the investor's costs and risks associated with entering a new market.

Eurotecnic's Euromel® melamine process (now in its fourth generation) accounts for more than 670,000 t/a in licensed nameplate capacity. Key features of the Euromel® melamine process are: easy urea-melamine integration, zero pollution, low energy consumption and high reliability.

Fig. 21: Advantage of integration for urea consumption

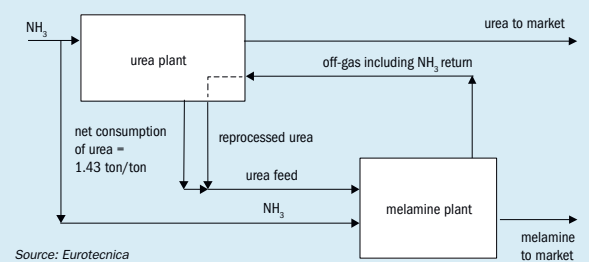

Source: Eurotecnic

Fig. 22: Eurotecnic integration scheme A – off-gas partial condensation

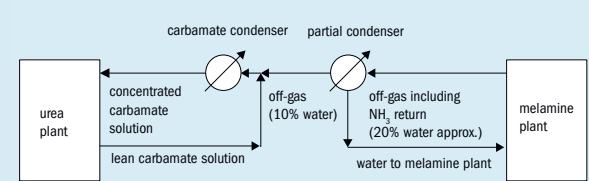

Source: Eurotecnic

Fig. 23: Eurotecnic integration scheme B – lean carbamate stripping

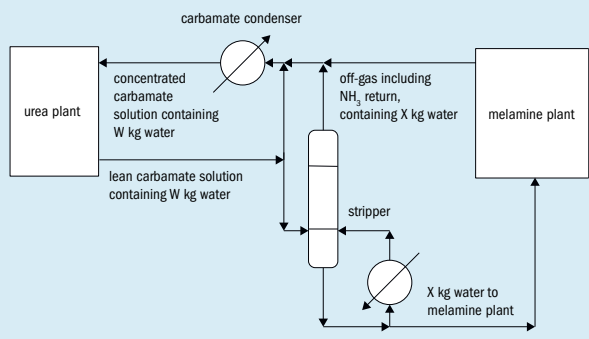

Source: Eurotecnic

Depending on the set-up, a Euromel® melamine plant can be run on urea or ammonia. Either one is the only raw material consumed.

Whatever the technology used for the upstream urea unit, the Euromel® melamine process ensures a net urea consumption of 1.428 t/t of melamine (Fig. 21). As the urea feedstock is by far the major cost of the opex, minimising feed-

stock consumption is a priority, and the way in which melamine off-gas is returned to the urea plant is of great importance.

There are several ways to integrate both plants and the first aim of Eurotecnic's approach is to avoid upsets of the urea and the melamine plants during their operation. This is achieved by having a simple reaction section design, which reduces as much as possible the use of machines operating under demanding conditions of temperature, pressure and risk of corrosion.

Equally important, is the flexibility and range of options to recycle the off-gases to the urea plant because no two urea plant are the same.

Newly developed integration schemes

Eurotecnic has developed, and patented, simple integration schemes that decrease (or even reduce to zero) the amount of water transferred within the off-gas from the melamine plant to the urea plant.

Scheme A: Off-gas partial condensation

The off-gas stream comes from a column where the gaseous melamine contained in the off-gas produced in the reaction is quenched and dissolved in water. The resulting off-gas is saturated in water (about 20% w/w). The partial condensation section (Fig. 22) comprises a partial condenser that condenses about 50% of water saturated with ammonia and carbon dioxide, which are recycled back to the melamine plant.

The resulting off-gas leaving the melamine plant contains only 10% water.

Scheme B: Water reduction by lean carbamate stripping

In the lean carbamate stripping scheme (Fig. 23) the off-gas from the melamine plant has, for example, X kg per hour water content. If the same amount of water, X kg per hour, is removed from the W kg of water contained in the lean carbamate coming from the urea plant and used to condense the off-gases, then the quantity of water contained in the concentrated carbamate recycled back to the urea plant is again W kg per hour.

In other words, no water is actually added by the melamine process to the carbamate stream used for off-gas condensation.

This is achieved by stripping ammonia and carbon dioxide from a stream of lean carbamate and by gathering these gases with the off-gas from the melamine plant, thus reducing the total water content. Water is sent from the bottom of the stripping column to the melamine plant.

Saipem urea scale up and integration technology

In a tough fertilizer market, producers need to differentiate their facilities with distinctive features that can give a competitive advantage. Examples include a diversified product portfolio, an outstanding production capacity or an optimised use of resources (raw materials and/or utilities).

In this context, technology providers can help by offering solutions that meet producers' needs, such as the possibility to scale-up the capacity and the easy integration of the technology with others.

The flexibility of Snamprogetti™ urea technology, licensed by Saipem, allows easy integration and the possibility to scale up plant capacity.

As regards capacity, Saipem has been the front-runner in reaching the target of 3,000 t/d and 4,000 t/d; today, Saipem is also ready to be the first to go beyond 5,000 t/d without changing its well proven and consolidated process scheme. The peculiar nature of Saipem as both licensor and contractor means it can assess the technical feasibility of each component considering all aspects (market availability, references, logistic/construction issues, etc.). A reliable cost estimate based on market inquiries for key equipment and a solid internal database have been used to evaluate the financial indicators, which demonstrate the high attractiveness of the investment. A pre-FEED for a 5,500 t/d unit has recently been completed.

As regards integration, Saipem has developed proprietary know-how for the recycling of melamine unit off-gases into a proven and reliable process scheme that can be optimised thanks to the three decomposition sections typical of the Snamprogetti™ urea technology, and which gives unique flexibility and behaviour. Depending on the melamine technology applied, the off-gases may be condensed, as appropriate, in the low, medium or high pressure section of the Snamprogetti™ urea process, in the existing condenser or in one added parallel. In particular, when the off-gases are at high pressure (containing a small amount of water), they can be easily condensed in the high pressure section to increase urea production. Medium pressure off-gases can be either recycled directly to the high pressure section after condensation and pumping or condensed together with the medium pressure gases of the urea unit. Low pressure off-gases

or large amounts of gases (compared to the size of the urea unit) normally need pre-treatment before recycling in order to minimise the water introduced for condensation in the stream sent to the urea plant.

As a contractor, one of the main challenges is to maximise energy efficiency, while ensuring a robust and flexible operation of the whole ammonia-urea complex. A keystone to hit this ambitious target is the smart integration of process plants and machinery with utilities and existing facilities (where applicable, such as in the case of revamping, expansion or brown-field projects), which lies in the astute design of complex steam and power systems. The aim is to optimise overall consumption levels, while ensuring robustness, flexibility and reliability in each operating scenario, matching all project boundary conditions and restrictions. The latter include the client's requirements and philosophies, interconnection with existing facilities, as well as ambient and geographical conditions.

The optimisation of steam and power systems is even more beneficial when applied to existing facilities. Saipem has recently been involved in a number of revamp studies with different targets, such as rehabilitation of units out-of-operation, modernisation of old fashioned plants, capacity increase, and energy savings. Among the other analyses carried out, there is an interesting case study represented by the combination of energy saving and capacity increase: by improving the performance of individual units (in close cooperation with licensors and machinery vendors) and with an intelligent integration of such improvements into the overall complex steam balance, it is possible to save a significant portion of the gas currently used in the facility and to convert it into additional production, which may vary from 5 to 20+%, depending on the available

budget for investment as well as on the operating years of the facility. The major improvements in turbocompressor design and fabrication facilitate a huge increase in the efficiency for units designed more than 10-15 years ago, whereas for relatively modern plants the gain is lower.

Casale integrated process design

Casale has a technology portfolio encompassing the entire fertilizer production chain from natural gas to final product and has developed various integrated approaches to the design or revamping of large fertilizer complexes. Two types of integration are possible:

- integration at the process level, which has an impact on the plant design, better exploiting the synergies between different units;
- integration at the engineering level, which has an impact on the project execution, improving the interaction between licensor, EPC contractor and end user.

One aspect of integration at the process level is the effective management of recycle streams from downstream plants. This aspect is particularly evident in urea-melamine integration. Casale has studied and developed an optimised integrated process (see Fig. 24) which produces melamine from ammonia and carbon dioxide taking advantage of the superior process features of the HP Low Energy Melamine (LEM™) process and the advanced concept of the Split Flow and Full Condenser urea process. The combination proposed by Casale allows the off-gas treatment section for the melamine plant to be designed as if it was a standard urea production plant, starting from 100% fresh liquid NH₃ and gaseous CO₂ feed. That is possible

Fig. 24: Casale fully integrated melamine and urea units

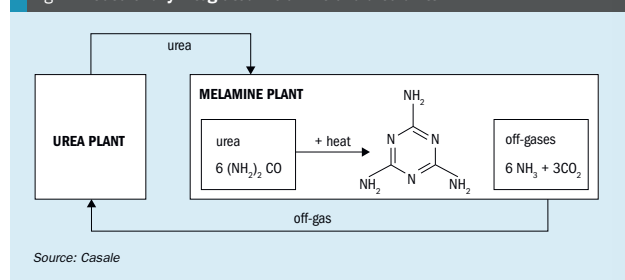

Source: Casale

Fig. 25: Integration project block diagram

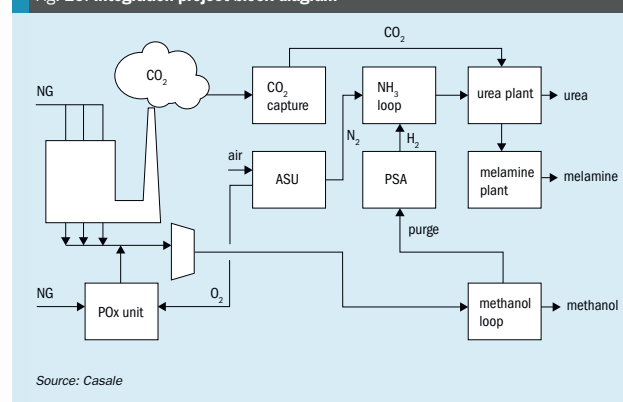

Source: Casale

because the produced off-gas is at high pressure and water-free.

Current project: Revamping of a methanol plant

Casale has worked with a methanol plant client for many years, initially to progressively increase the capacity of the methanol plant (designed in the 1980s) and optimise the energy consumption. Lately the focus has moved on to the integration with new units to produce ammonia and melamine. This involves the design and installation of new partial oxidation reactor, air separation and carbon dioxide recovery units, along with a completely new urea plant and a melamine plant. New storage facilities for ammonia, urea and melamine were also required.

Project basis

Starting in the 1990s, the first revamp was focused on the modernisation of the methanol synthesis converters, applying Casale ARC technology to increase the capacity of methanol production from 2,000 t/d to 2,500 t/d.

A further capacity increase was achieved in the 2000s, reaching the level of 3,000 t/d, based on the Casale Isothermal Methanol Converter (IMC) technology. This was applied to an additional synthesis converter, together with the modernisation of some areas of the primary reformer.

The last revamping step, implemented in 2016, increased the methanol capacity to 3,375 t/d. This involved a new partial oxidation (POx) reactor, in parallel with the existing steam reformers, to generate the

required synthesis gas for the methanol production. This last modernisation step was the starting point for early studies of the integration project, aimed at producing ammonia, urea and melamine.

The composition of syngas from steam reforming (the most important constituent in this methanol plant) is not optimal for methanol synthesis, as it contains an excess of hydrogen (from downstream of the synthesis reactions) which must be purged from the synthesis loop. Such a stream, typically recycled as fuel to the primary reformers, can be more efficiently used for the synthesis of ammonia, being hydrogen rich. The scheme adopted in the latest modernisation step of the methanol plant featured a new partial oxidation (POx) section, including an air separation unit (ASU) necessary to provide the oxygen required by the new POx reactor. At the same time the new ASU made available the nitrogen necessary for the ammonia synthesis. This nitrogen is currently used for utilities services only. This is the first step of the integration and product diversification: from methanol purges to producing an ammonia product.

Subsequently, the urea production (the second step of the product diversification path) can be exploited by recovering the second reactant (the carbon dioxide) from the flue gas of the existing primary reformers of the methanol units. The third and last step is the design of a melamine plant, for which the raw materials are already available.

Based on the above, Casale has developed an integrated and optimised process

solution featuring a 1,000 t/d ammonia synthesis unit, a 1,750 t/d urea plant and a 120 t/d melamine plant (Fig. 25).

Casale is acting as single point of responsibility for the engineering, procurement and commissioning for the project. All the required technologies are within the technological portfolio of one single licensor (Casale) and the contract foresees the inclusion of the utilities and off-sites facilities as within the scope of the engineering.

The complex is planned to be in operation by the middle of October 2020.

Methanol plant

One of the main objectives of the project, and an essential requirement imposed by the client, is to ensure that the newly installed downstream unit operations do not affect the methanol production at all. The new complex must be robust and must protect the methanol plant against any possible operational disruption.

The interfaces between the units have been studied to ensure the complete independence of the methanol plant operation, in case of any shutdown and/or unbalanced operation of the new complex. This objective is achieved by the use of a venting approach, implemented through an emergency shutdown system. This freezes the operation of the existing plant, enabling the operators to recover the previous operating conditions.

Ammonia unit

The existing methanol plant makes the raw materials available to feed the new production complex. The innovative idea is to add value to streams that were considered to be waste, or were required purges from the main process line, such as the reformer flue gas (waste stream) or the methanol synthesis purge stream (a required purge used as fuel).

It seems obvious to view the purge gas stream as a potential hydrogen source. The gas purged from the methanol synthesis loop is fed and treated in a new pressure swing adsorption unit (PSA) to recover most of the hydrogen at high pressure, minimising the following compression energy. The tail gas is obtained at low pressure (an obligatory compromise to having the high pressure and hydrogen rich stream), then compressed (using a steam turbine driven compressor) and delivered to the existing methanol reformers fuel system. The recovered hydrogen has a very low inert gas content and matches

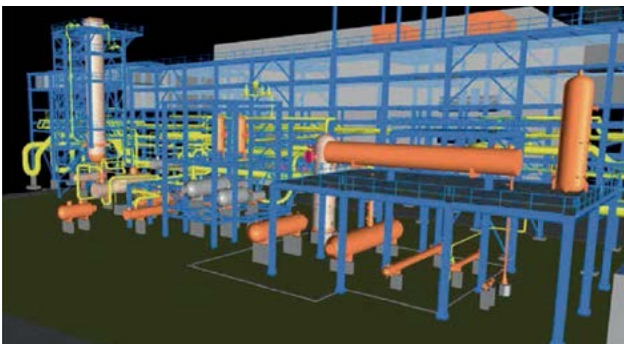

Fig. 26: Casale inert-free NH₃ loop.

the specification for the maximum level of oxygenated components, avoiding any potential poisoning of the reactor catalyst (Fig. 26).

The nitrogen required for the synthesis of the ammonia is supplied by the existing air separation unit (ASU) at low pressure (two feeding pressures) and it is compressed (using an integrally geared machine) to the recovered hydrogen pressure before being fed into the loop. The nitrogen also matches the specification for the maximum level of oxygenated components.

As both the hydrogen and the nitrogen are very pure and devoid of inert gases, the new ammonia synthesis loop design is similar to comparable projects developed by Casale in China. Casale has a long and successful history of developing inert-free and purge-free synthesis loops coupled with refrigeration systems, designed and implemented in China, with over 40 such applications implemented in the Chinese market.

The synthesis loop operates at about 140-150 kg/cm²g and the ammonia converter is designed in accordance to the well-proven features of the Casale converter: three catalytic beds (Fig. 27), axial-radial gas path with inter-bed cooling and cold pressure vessel design.

The heat recovery section of the synthesis loop is optimised in accordance with the requirement of the new complex: generation of 40 kg/cm²g and 380°C steam is combined with that produced by the external package boiler. The widely used Casale direct connection (Fig. 28) between the outlet nozzle of the ammonia converter and the inlet nozzle of the first heat exchanger of the loop (steam superheater) enhances the reliability of the loop.

The ammonia condensation is achieved in two steps: the first stage uses cooling water (about 40% of total capacity) and the second uses evaporating ammonia. Evaporating ammonia is the same product compressed and then evaporated before being delivered to the storage facilities.

Both plant compressors, synthesis and ammonia, are driven by electric motors.

Under normal operating conditions a production capacity of 894 t/d of liquid anhydrous ammonia is expected. Most of the total capacity will be fed to the urea plant via storage facilities used as a buffer.

Carbon dioxide recovery (CDR) unit

The second waste stream to be exploited is the flue gas coming from the convective sections of the existing reformers. The carbon dioxide in the flue gas is recovered and used to complete the urea conversion. The CDR unit, licensed by Mitsubishi, is based on activated amine washing technology and is referenced worldwide for this application (and for larger capacities).

The flue gas from the reformer is extracted from the stacks, then quenched with cooling water and fed via an electric motor driven blower to the CDR absorption unit. The carbon dioxide is absorbed by the amine washing solution in the absorber column and released in the regenerator column, heated by low pressure steam. The clean and water-saturated carbon dioxide is then delivered to the CO₂ compressor in the urea plant.

Urea unit

The urea plant is based on the Casale Split Flow™ Loop and Full Condenser™ technology. The plant is designed for a nominal capacity of 1,750 t/d of urea as molten

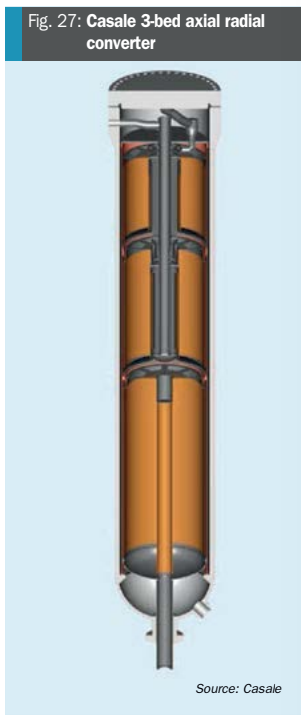

Fig. 27: Casale 3-bed axial radial converter

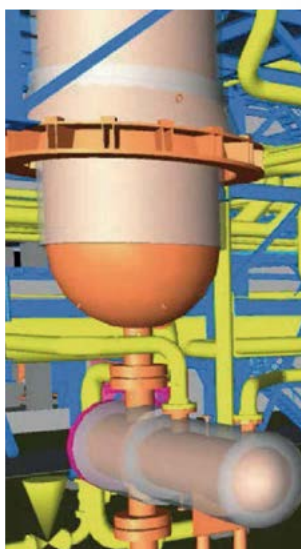

Fig. 28: Casale direct connection.

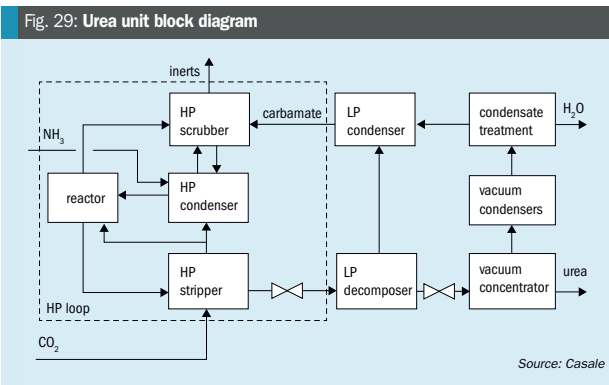

Fig. 29: Urea unit block diagram

urea at 99.7%, used to feed the melamine unit (370 t/d of product) and the prilling tower (1,380 t/d of product). The synthesis loop comprises a high pressure stripper, high pressure carbamate condenser (full condenser), urea reactor and high pressure scrubber. The configuration of the high pressure (HP) loop is aimed to minimize the amount of inert gases present in the reactor, in order to achieve the optimum urea conversion. The urea reactor is equipped with Casale-Dente high efficiency trays which guarantee a very high conversion rate of carbon dioxide to urea (Fig. 29).

All critical parts of the high-pressure loop are manufactured utilising the innovative Casale-Tubacex superduplex material named Uremium29 that enables the plant to operate with minimum oxygen content.

The plant is designed to be totally integrated with the melamine unit, including a provision for melamine off-gas recycle,

common steam network and common ammonia availability. The double-stage evaporation sections ensure formaldehyde-free urea is supplied to the melamine plant, as well as ensuring a low biuret content in the urea prills.

The contaminated water, separated in the vacuum evaporation section, is treated in a hydrolysis unit, featuring the Casale high efficiency hydrolyser, where ammonia and urea are removed down to a level of 1 ppm. This enables the treated condensate to be reutilised as boiler feed water within the complex.

Melamine unit

The melamine plant has a nominal capacity of 120 t/d, and is designed according to Casale's Low Energy Melamine (LEM™) technology, which guarantees high efficiency in terms of raw material consumption and energy, and ease of integration with the urea unit

The main features of Casale's LEM process are the high pressure dual-reactor synthesis, the high pressure urea off-gas scrubber and the choice of NaOH as the alkaline agent for the hydrolysis section (Fig. 30).

The advanced process configuration with dual high pressure reactors enables the achievement of over 96% melamine conversion. The second reactor operates with the addition of high pressure ammonia, which serves to:

- completely strip dissolved CO₂ in the raw melamine melt from the first reactor;
- enhance the conversion of reaction intermediates to melamine;
- decrease the melam content in the synthesised melamine.

The off-gas from both reactors contains CO₂ and NH₃ which will be recycled back to the urea plant. In order to prevent melamine from reaching the urea unit, the off-gas is washed by counter-current contact with molten urea at a controlled temperature.

The advantage of using urea scrubbing is that it improves the quality of the off-gas recycled to the urea plant, which is water-free. This helps to improve the conversion efficiency of the urea reactor. The consequence is that the specific energy efficiency of the urea plant, when linked to the melamine plant, remains at the same level as a standalone urea plant. This feature also has the benefit that the installation (investment and maintenance costs) of the urea plant does not significantly change when it is integrated with the melamine unit.

An additional advantage of the scrubbing unit in the melamine process is that

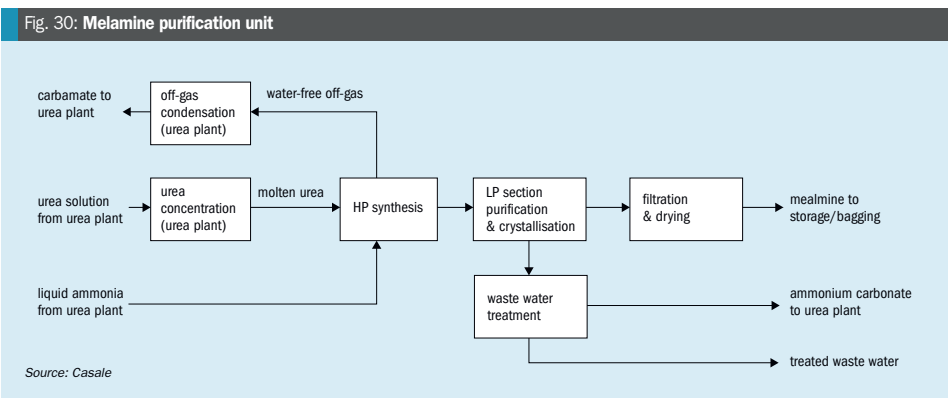

Fig. 30: Melamine purification unit

it provides a preheating step for the molten urea which is fed to the melamine reactor, contributing to improving the energy efficiency of the melamine synthesis section.

The availability of off-gas at high pressure (107 kg/cm² g min.) and high temperature, generates the following benefits for both the melamine and urea units:

- the ability to recover the condensation heat through steam generation;
- minimising the carbamate required for off-gas condensation and the quantity recycled to the urea plant;
- recycling the carbamate to the urea synthesis at a high temperature (more than 150°C), contributing to energy efficiency.

In the purification section, sodium hydroxide is used as an alkaline agent to promote the hydrolysis of polycondensates and transform the oxy-amino-triazines (OATs) into their more easily soluble sodium salts, avoiding its precipitation in the following crystallisation step.

The choice of sodium hydroxide, as the alkaline agent, is due to its low volatility and high strength, which provide the following benefits:

- lowest operating and design pressure, enabling low cost equipment and reduced energy consumption for the mother liquor recycling;
- higher solubility of the OATs in the mother liquor, which can be recycled back to the process without special treatment;
- minimisation of mother liquor purging to the waste water treatment and the melamine loss.

Utilities

Ammonia storage is used as a buffer tank between the ammonia and urea plants, smoothing reciprocal imbalances and different production batches and requirements of ammonia.

In order to safeguard the operation of the methanol plant, the new industrial complex has been designed to have completely independent utilities networks. Only a few pipe lines for steam and demin water are connected to the existing methanol plant: it is anticipated that the new complex will utilise these resources from the existing plant for commissioning and pre-commissioning activities.

The ammonia synthesis loop, the PSA section and the relevant ammonia storage system are equipped with a dedicated flare system to cope with short term fluctuations and emergency operation.

AdWinCombined™: highly integrated ammonia/methanol coproduction

AdWinCombined™ is an evolution of AdWinMethanol® technology and Uhde Ammonia technology. It allows production of both methanol and ammonia in a highly integrated plant concept which ultimately leads to savings in opex and capex of up to 30% compared to two separate conventional process plants. The process concept features the simultaneous operation of both product plants at nameplate capacity but also provides the freedom of operation at partial loads. Furthermore, single product operation modes are possible, i.e. one product line (methanol) can continue to operate while the other product line (ammonia) is shut down and vice versa.

AdWinCombined™, a joint process development of thyssenkrupp and GasConTec, is based on proven equipment, but utilises an advanced and highly integrated process arrangement (Fig. 31) with a single syngas production island, the core of which is an oxygen-driven catalytic partial oxidation reactor (autothermal reactor). The set-up of the methanol synthesis corresponds to that of AdWinMethanol® with two sequential isothermal reactor stages and an intermediate condensation. The purge gas from the methanol synthesis is used as feedstock for the ammonia unit based on uhde® ammonia technology.

Process arrangement highlights

Single syngas production island
AdWinCombined™ uses a catalytic POx (ATR) for syngas production and a steam reformer is not required. Deleting the steam reformer reduces capex and makes the operation of

the plant more reliable and simpler. Furthermore, the previous pressure limitation of the reforming falls away and so it is possible to operate the syngas production at elevated pressure which leads to smaller equipment and smaller pipelines.

In addition, the higher pressure in the syngas production section leads to much smaller pressure differences over the two syngas compressors, the methanol and ammonia syngas compressor. This leads to lower capex and a much higher reliability of the plant.

Syngas conditioning – high temperature CO shift conversion

In contrast to conventional ammonia plants only a HT shift is used to increase the hydrogen content. A low temperature shift, with a costly and sensitive catalyst, is not needed. By varying the flow rate through the HT shift, the production ratio of methanol and ammonia can be adjusted.

Syngas conditioning – CO₂ removal

Only a simple and energy-efficient CO₂ bulk removal is required. A complete CO₂ removal as in conventional ammonia plants is not needed. Since the CO₂ removal unit is located upstream of the methanol synthesis, it ensures a low-CO₂ syngas, which results in a reduced hydrogen demand for the desired methanol production.

Syngas preparation for ammonia synthesis

For the preparation of a suitable syngas for the ammonia synthesis no methanation is required in contrast to conventional ammonia plants. AdWinCombined™ uses a robust and flexible pressure swing adsorption (PSA) system that ensures the

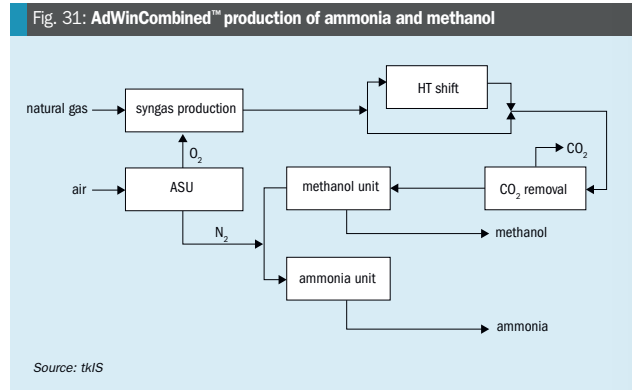

CRU Nitrogen + Syngas 2019

4-7 March 2019 • Estrel Hotel, Berlin, Germany

Promoting and developing best practice and innovation in the global nitrogen industry

6 great reasons to attend Nitrogen + Syngas 2019:

- ✓ **Share operational experience** and best practice with 700+ professionals from 50+ countries
- ✓ **Expand your knowledge** with technical papers covering syngas, ammonia, urea, and nitrates
- ✓ **Develop practical solutions** to operational problems through detailed case studies
- ✓ **Learn** about the latest technological and process innovations
- ✓ **Address** your technical challenges with a range of 80+ world-class exhibitors
- ✓ **Understand** the global and regional drivers shaping industry in 2018 and beyond

“Excellent platform for knowledge sharing, networking with delegates from key players of syngas, nitrogen and fertilizer units from all over the world, and exposure to latest developments and operating strategies development.”

Waqas Shehryar, Process Engineer, Fatima Fertilizer Co. Ltd.

Who will you meet in Berlin?

Delegate by business activity

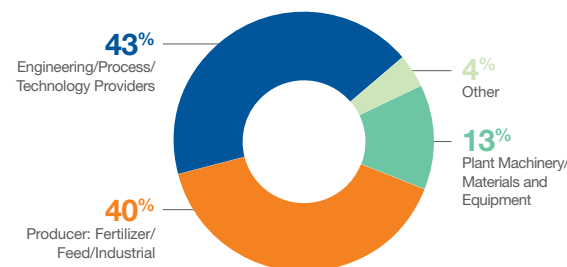

Companies who attend include:

Abu Qir Fertilizers Company • Acron • Alexfert • Ballance Agri-Nutrients • Borealis • Brunei Fertilizer Industries • CF Fertilisers • Togliattiazot • Engro Fertilizers • EuroChem • Fatima Fertilizer • Fauji Fertilizer • Fertiberia • FERTIL • GCT • Grupa Azoty • Gujarat State Fertilizers • GPIC • Helwan Fertilizers Company • J R Simplot • KAFCO • KazAzot • Kermanshah Petrochemical Industries Co. • LYB • Ma'aden • MAXAM TAN • Metafrax • MOPCO • NAK Azot • Nitrogénművek • Notore • OCI Nitrogen • Maxam-Chirchik • OMIFCO • Omnia Fertilizer • Pardis Petrochemical Co. • PCS Nitrogen • PIC • Petrokemija Plc • Petrokimia Gresik • PetroVietnam • PhosAgro-Cherepovets • PotashCorp • QAFCO • Razi Petrochemical Co. • Rustavi Azot • SABIC • Salalah Methanol Co. • SKW Stickstoffwerke Pleisteritz • Tomet • URALCHEM • Yara

and many, many more

Sponsors:



Official publications:

Supporters:



For more information and to book your place, visit www.nitrogensyngas.com

CONTENTS

What's in issue 355

COVER FEATURE 1

India's 'methanol economy'

COVER FEATURE 2

Industrial grade ammonium nitrate

COVER FEATURE 3

Technology integration

COVER FEATURE 4

Inert catalyst support

NITROGEN+SYNGAS
ISSUE 355
SEPTEMBER-OCTOBER 2018

BCInsight

Southbank House, Black Prince Road
London SE1 7SJ, England
Tel: +44 (0)20 7793 2567
Fax: +44 (0)20 7793 2577
Web: www.bcinsight.com
www.bcinsightsearch.com

Table 2: AdWinCombined™ ammonia/methanol coproduction benefits

	Separate units	AdWinCombined™	Improvements
Syngas production	two separate syngas production units – combined reforming (SMR & ATR)	one common syngas production unit – catalytic partial oxidation (ATR) only	<ul style="list-style-type: none"> ● steam reformer not required ● fewer reactors ● smaller ATR reactor due to higher pressure
Syngas conditioning	two separate systems	one highly integrated system	<ul style="list-style-type: none"> ● significantly reduced natural gas consumption ● no methanation required ● no LT shift required
Syngas compressor	high ΔP	low ΔP – applies to methanol and ammonia compressor	<ul style="list-style-type: none"> ● significantly smaller compressors ● more reliable operation
Nitrogen addition to ammonia plant	air to secondary reformer	nitrogen is added just before the ammonia reactor	<ul style="list-style-type: none"> ● reduced gas streams ● smaller pipes and equipment
Methanol synthesis	2-stage reactor system with two different reactor types	2-stage reactor system with one reactor concept and design/intermediate condensation	<ul style="list-style-type: none"> ● simplified design (isothermal reactors for both stages) ● higher COx conversion ● lower recycle flow rate ● lower catalyst volume in second stage
Ammonia unit	hydrogen-rich stream including inert gas	hydrogen and nitrogen streams contain only small traces of impurities	<ul style="list-style-type: none"> ● significantly reduced recycle stream in the ammonia plant ● significantly smaller recycle compressor ● smaller pipes and equipment ● significantly less or no purge gas
Offsites and utilities	two separate systems	one steam and condensate system	<ul style="list-style-type: none"> ● reduced investment costs

production of high purity hydrogen from the purge gas of the methanol synthesis.

Methanol synthesis (AdWinMethanol®)

In contrast to conventional methanol technologies, AdWinMethanol® employs state-of-the-art isothermal reactor types in both reactor stages. This does not only simplify the design and operation of the reactors, but also significantly reduces the catalyst volume required in the second stage.

Furthermore, the product methanol is separated by intermediate condensation, resulting in two positive effects. Firstly, the recycle flow, and hence the flow to the second reactor stage, can be reduced. Secondly, the methanol removal increases the driving force (equilibrium) for the methanol synthesis, resulting in higher COx conversion rates and a higher methanol production.

Ammonia unit (Uhde Ammonia technology)

Pure nitrogen from the air separation unit is mixed with pure hydrogen upstream of the ammonia syngas compressor. Due to the absence of inert components in the syngas, the ammonia plant is consider-

ably simplified compared to conventional arrangements.

Due to the superior new concept for a highly integrated ammonia/methanol coproduction complex, significant benefits can be achieved as shown in Table 2.

The main advantages of AdWinCombined™ technology for the owner/operator are:

- more reliable;
- up to 30% lower EPC cost, resulting in lower total installed cost (TIC);
- up to 10% less natural gas consumption;
- high flexibility of operating the complex;
- reduced environmental footprint;
- reduced maintenance cost.

uhde® ammonium sulphate process integration

Fertilizer complexes present multiple opportunities to increase competitiveness by effective integration. An effective integration doesn't have to be in the same business field, all local industrial processes have to be considered.

Take, for example, the production of ammonium sulphate fertilizers. One option

to produce ammonium sulphate fertilizer is from an aqueous ammonium sulphate solution, a byproduct or waste product in various industrial processes such as caprolactam or coke plants. Despite the energy-consuming process of vaporising the water to produce solid fertilizers, a growing demand for sulphur fertilizer still makes this process worthwhile.

Increasingly stringent environmental regulations over the last decades have reduced sulphur dioxide emissions and acid rain which has consequently led to sulphur deficiencies in some soils. Ammonium sulphate fertilizer releases sulphur and nitrogen into the soil to ensure an optimum crop yield.

Ammonium sulphate fertilizer is mostly marketed as crystals. However crystals are difficult to handle and spread across fields and cannot be used in bulk blends, hence they have significant disadvantages compared to granular fertilizer products.

Ammonium sulphate granules have improved handling, spreading (>42 m) and mixing properties, making bulk blending possible. The typical product specification for ammonium sulphate granules

Fig. 32: Ammonium sulphate crystalliser and granulator integration

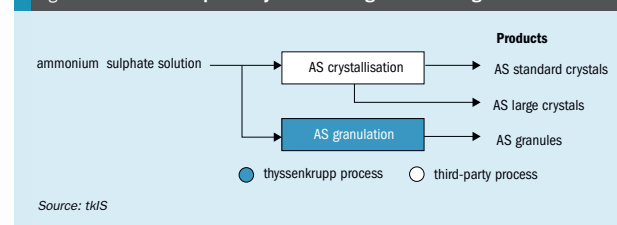

meets all fertilizer standards. In addition, the granules dissolve more homogeneously than crystals, thus enabling a gradual, controlled release of nitrogen and sulphate into the soil.

A typical product specification for ammonium sulphate granules is:

- Nitrogen content: 21 wt-%
- Sulphur content: 24 wt-%
- Moisture: < 0.5 wt-%
- Hardness: 3,000 g
- Bulk density: 750-850 kg/m³
- Diameter 2-4 mm: 90%

The uhde® ammonium sulphate fluidised bed granulation process makes a premium product compared to crystalline ammonium sulphate. With its application advantages, granular product can achieve a significantly higher price. It is produced by only a few suppliers in relatively small quantities.

In general, the integration of this new process into existing chemical complexes is essential for improved economics e.g. for better energy integration, not only within the plant, but also from other available heat sources. If steam or hot off-gases are available at the production site, even at low calorific value from adjacent plants, they can

be used to reduce operating costs. Furthermore, if a fluidised bed granulation plant is installed in parallel to a crystalliser (Fig. 32) the load of the crystalliser will be reduced. This may be of interest if the capacity of the process creating the ammonium sulphate solution as a side product, e.g. caprolactam, will be increased. Parallel installation would also have the benefit of producing larger crystals. The economic benefit would be twofold: higher prices for granules from the new fluidised bed granulation plant and an improved premium for larger crystals.

All sources of ammonium sulphate solutions are a potential feed for the granulation plant. Even residue streams with higher contamination can be granulated, making it possible to turn a waste disposal cost into a valuable product.

Another possibility of process integration besides the combination of crystallisation and granulation is the incorporation of the uhde® ammonium sulphate process into an existing fertilizer complex with ammonia and urea and/or nitric acid and ammonium nitrate production, as shown in Fig. 33. The enormous energy surplus in the form of steam can be used in the granulation, which significantly reduces

the operating costs of both processes and thereby improves the profit margin. Additionally the ammonium sulphate solution can be combined with ammonium nitrate melt to form ammonium sulphate nitrate. The fluidised bed granulation is able to generate ammonium sulphate and ammonium sulphate nitrate granules. In addition to good market prices for ammonium sulphate nitrate, the product portfolio will be expanded increasing the competitiveness of the fertilizer complex.

References

1. Scotto A.: "A single partner for all your needs: from gas to solid fertilizers, methanol and melamine", IME 2016.
2. Strepparola E. and Scotto A.: "Opportunities created by the innovative revamping of a methanol plant", paper presented to the International Fertiliser Society Conference, Prague, Czech Republic (May 2018).
3. Di Ruocco G.: "Integrated process designs – Euromel® melamine/urea complex", written for Nitrogen+Syngas (Aug 2018).
4. Pach J.: "Integrated process design", written for Nitrogen+Syngas (Aug 2018).
5. Gurhan D and van der Zande H.: "Urea technology integration for added value", written for Nitrogen+Syngas (Aug 2018).
6. Anderzhanov R.: "A new urea solution and UAN plant based on the existing standby facilities", Nitrogen+Syngas 2018 Conference, Gothenburg, Sweden (Feb 2018).
7. Sala M.: "Creating value for the fertilizer market", written for Nitrogen+Syngas (Jun 2018).
8. Schulz A.: "AdWinCombined™ – highly integrated and optimized production of ammonia and methanol", written for Nitrogen+Syngas (Aug 2018).
9. Rath M.: "uhde® ammonium sulfate process – Increased competitiveness by effective integration", written for Nitrogen+Syngas (Aug 2018).

Fig. 33: Fertilizer complex integration

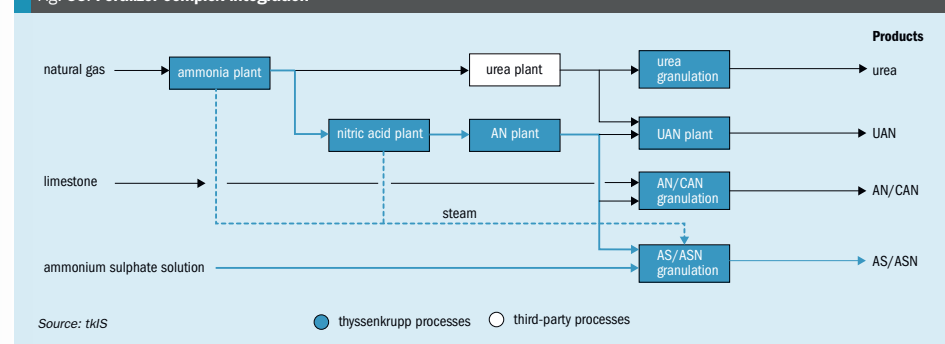

Inert catalyst support and hold-down media

Materials science continues to develop and choosing the correct media for syngas applications can create significant value for a customer. The latest market leading developments in catalyst support and hold-down media provide innovative solutions to improve the performance, reliability and availability of syngas plants.

The predominant trend over the past decades has been a significant increase in the capacity of syngas units in order to maximise economy of scale. As process designs evolve, the operating parameters around autothermal reformers and oxygen-blown secondary reformers have increased in severity. This effect, compounded by the increasing pressure on many plant operators to maximise uptime, means that catalyst support solutions that were adequate years ago are no longer sufficient. New and innovative solutions are needed to meet today's competitive industrial requirements.

The most common catalyst support media come in the form of alumina or ceramic balls in a variety of sizes ranging from 3 mm to 100 mm. While balls are the most common shape used, other shapes such as hollow rings, cogs or unique shapes are also available.

At a simple level the prime function of an inert support media is to protect and support the catalyst bed whilst ensuring that the process gas is optimally distributed. In addition, the media should not be adversely affected by process operating conditions.

Secondary reformers and autothermal reformers are very severe applications. The high temperature steam and hydrogen can cause metal oxides such as silica and soda to corrode and eventually deposit downstream in the catalyst bed or waste heat boiler leading to premature shutdown. The higher the temperature, the faster the corrosion occurs. Forces within the vessel can also cause catalyst and media to churn or uplift. Therefore, it is crucial to select the correct inert media to support the catalyst from above and below.

The most important factor is that the media is manufactured from refractory

raw materials with very low levels of silica (typically at least less than 0.35%). In the bottom of the unit above the alumina support dome or cone, it is most common for high alumina, low silica support balls to be used. The media is typically graded by size, from a smaller size ball supporting the catalyst down to a larger size determined by slots in the support dome (or cone) and pressure drop considerations. There are several alternatives for hold-down media to be used above the catalyst, where the most severe conditions are found.

Some syngas plants only allow alumina balls on plant site so that ceramic balls, which are primarily made from naturally occurring aluminosilicate clays, are not mistakenly loaded in the secondary reformer or high-temperature shift unit (HTS).

Ceramic media are suitable for moderate applications and ceramic balls are commonly used in low- or medium-shift units (LTS or MTS), desulphurisers, dryers and guard beds.

Christy Catalytics catalyst bed support media

Christy Catalytics, one of the world's largest suppliers of engineered inert catalyst bed support media, has been supplying industrial ceramic and refractory materials to the global syngas market since 1952.

Christy's signature products include PROX-SVERS® catalyst bed support balls made of high purity alumina or clay and CUSTOM-CRAFTED™ alumina hexagonal target tiles.

Proper selection of the hold-down media in secondary reformers and autothermal reformers is very important for catalyst protection.

The first option is large diameter alumina balls, such as 50 mm or 76 mm T-46 (95% Al₂O₃ chemically bonded alumina) or T-99 (99.0 or 99.5% Al₂O₃ sintered alumina) PROX-SVERS (Fig. 1). 99.5% alumina media is recommended for units with a temperature and environment conducive to severe corrosion of metal oxides. The mass of the larger balls makes them less likely to become displaced by gas flow than smaller support balls, and their spherical nature gives them a predictable pressure drop. Both grades contain minimal levels of silica.

A second hold-down option is hexagonal target tiles (Figs. 2 and 3). Hexagonal tiles are the least likely to mill or churn in a vessel. In particular, Christy's largest size, Super Jumbo, weigh approximately 23 kg are 87.5 mm thick, and are very unlikely to move and expose the catalyst during upset conditions. Smaller sizes (Jumbo and Standard) are also available. All tiles come with hole patterns designed to minimise pressure drop while maintaining physical integrity, however the quantity and pattern of the holes may be customised based on the performance objectives and dynamics of the specific unit. For instance, if flame impingement beneath the burner is an issue, solid tiles may be installed in the middle of the vessel, protecting the catalyst and forcing

Fig. 1: T-99 PROX-SVERS alumina balls



PHOTO: CHRISTY CATALYTICS

Fig. 2: Hexagonal target tiles and circle brick



PHOTO: CHRISTY CATALYTICS

Fig. 4: Alumina lumps



PHOTO: CHRISTY CATALYTICS

Fig. 5: CATA-COGS™ media



PHOTO: CHRISTY CATALYTICS

the process gas stream to better distribute through the entire tile layout. Pre-cut special shapes are typically installed around the vessel perimeter to minimise gaps along the vessel wall, and circle brick may be installed along the wall between the catalyst and hexagonal tiles to form a seal and prevent gas bypass.

Plants may select the type of tile based on the velocity in the vessel, the distance between the burner and the bed, and the nature of any problems that may have been experienced in the past. All hexagonal tile shapes are made with wear-resistant 99% alumina and have an ultra-low silica content.

Christy's newest tile, HT-LC, is formulated to resist corrosion and is superior to alumina. It is designed for corrosion resistance in secondary reformers and ATRs and

provides superior hold down due to its 60% greater density than 99% alumina tiles.

A third option for hold-down media is white fused alumina lumps (Fig. 4), specified by some ammonia and methanol licensors as bed support/topping. While many plants continue to use lumps over other options, there are several disadvantages to this type of media. Alumina lumps are made by melting alumina in an electric arc furnace and casting the molten material onto the floor. The material is then shattered, resulting in irregularly shaped pieces and jagged edges. The material is screened into a size range, but it is possible for long, narrow shards to make it through the screening process. The irregular size of the lumps and their tendency to chip can result in higher pressure drop. Corrosion is also more likely due to the open structure of the

Fig. 3: Close-up of a hexagonal target tile layout



PHOTO: CHRISTY CATALYTICS

lumps. In addition, the long, narrow shards can penetrate down into the catalyst bed leading to channeling.

Hold-down media volume

When 50 mm or 76 mm support balls are utilised as a hold-down media in the top of secondary reformers, a minimum bed thickness of 150 mm is required, and 225 mm is preferred. Alumina lumps require a minimum bed thickness of 300 mm. Beds comprised of hexagonal target tiles vary between 50 mm and 87.5 mm, depending upon the tiles selected. For plants that have experienced bed churning or erosion issues directly beneath the burner, a small area of 150 mm thick, solid tile may be considered.

Pressure drop

Due to their irregular size, tendency to chip, and thicker bed volume requirement, alumina lumps frequently have the highest pressure drop of the media options discussed herein. Large alumina support balls have significantly less due to their round surface, consistent void volume, and reduced bed thickness. Furthermore, 76 mm support balls have approximately 30% less pressure drop than 50 mm. Finally, with their comparatively thin layer thickness, and open hole patterns, hexagonal tiles have the lowest pressure drop of all hold-down media options.

For shift units, Christy's CATA-COGS™ media (Fig. 5) can be used as both bed support and hold-down media. These high-density cog-shaped media are made from 99% alumina and are available in sizes from 16 mm to 85 mm. They have a lower pressure drop versus balls due to the increased void fraction. The larger sizes may be hand placed around the collector, layering smaller sizes above until the catalyst bed is reached. A downside to using very large media is that they must be removed by buckets as they are generally too large to be removed by vacuum truck.

CONTENTS

What's in issue 355

COVER FEATURE 1

India's 'methanol economy'

COVER FEATURE 2

Industrial grade ammonium nitrate

COVER FEATURE 3

Technology integration

COVER FEATURE 4

Inert catalyst support

NITROGEN+SYNGAS
ISSUE 355
SEPTEMBER-OCTOBER 2018

BCInsight

Southbank House, Black Prince Road
London SE1 7SJ, England
Tel: +44 (0)20 7793 2567
Fax: +44 (0)20 7793 2577
Web: www.bcinsight.com
www.bcinsightsearch.com

Fig. 6: Denstone® 99 product group



PHOTO: SAINT-GOBAIN NORPRO

Denstone® 99 for extreme syngas environments

Saint-Gobain NorPro is a world leader with its Denstone® brand of support media (Fig. 6), which has become synonymous with consistency, reliability and structural integrity. Denstone was the first ceramic support media introduced over 70 years ago to address the need for an inert support media that would retain the catalyst in fixed bed reactors without contaminating the process. Today, the support media portfolio includes:

- Denstone® deltaP® engineered shaped support media that achieves more with less;
- Denstone® 2000 support balls designed for severe hydroprocessing applications;
- Denstone® 57 support balls, the original industry standard;
- Denstone® 99 high-purity alumina support balls for high temperature steam applications.

Denstone® 99 alumina balls are utilised in synthesis gas production because of their high alumina, low silica composition, which withstands the most severe environments while delivering added value in fixed bed catalyst applications.

The purity and high strength of Denstone® 99 support balls make it ideal for high temperature and steam applications such as secondary reformers in ammonia plants. The minimal silica content allows the spheres to be chemically inert to prevent fouling of the catalyst bed or coating of

downstream equipment. The product's high density and thermal conductivity make it the ideal media for heat transfer. Denstone 99 high-alumina balls provide several benefits to syngas producers:

- High purity – Denstone® 99 support balls are 99+% alpha alumina. With a maximum silica content of only 0.2% Denstone® 99 protects the catalyst bed and downstream equipment from fouling and coating caused by leached silica.
- Excellent thermal properties – Due to their high density, Denstone® 99 spheres can withstand temperatures up to 1,650°C, so they are an excellent choice for heat retention and equilibration media.
- Superior chemical resistance – Denstone® 99 spheres can withstand the reactive environments of applications with olefin processes, such as ethylene dryers, where polymerisation could be a problem with a less chemically resistant material.
- High strength – Denstone® 99 balls are manufactured to eliminate spalling and delamination within the reactor and prevents the occurrence of chipping, protecting the bed from plugging associated with the collection of splinters and fines.

Denstone® 99 support balls are available in 11 sizes ranging from 75 mm for extra weight and hold-down capability, down to 1.5 mm to support very small diameter catalysts.

Johnson Matthey specialist support and hold-down media technologies

Johnson Matthey (JM) possesses unrivalled know-how in selecting appropriate catalyst supports and hold-down media for syngas plant applications.

In areas in which established materials technologies were inadequate JM has led the way in developing advanced solutions, such as STREAMLINE™ support technology for reactor pressure drop saving and zirconia based KATALCO™ 94-1ZT tiles for use in autothermal reformer (ATR) designs in

Fig. 7: DYPOR support media



PHOTO: JM

which erosion of traditional alumina tiles caused unreliability.

JM's latest development in technology combines strong purification expertise with the design of low pressure drop systems for shift reactors to develop PURASPEC™ 2272 - an 'adsorbing inert'.

PURASPEC 2272 is a low pressure drop active adsorbent support media that replaces the inert support media at the bottom of the high temperature shift (HTS) reactor and captures chloride which would otherwise poison the low temperature shift (LTS) catalyst downstream.

Historically, most supports and hold-down materials have been supplied in the form of balls, which come in a range of sizes dependent upon the application.

In contrast, JM offers support balls and high voidage DYPOR™ media (Fig. 7) in either high purity alumina or aluminosilicate form (Table 1).

High voidage DYPOR media is used in shift reactors as STREAMLINE low pressure drop support. It is also used as SHIFTSHIELD, which protects the top of a catalyst bed by capturing boiler solids and by preventing the impingement of liquid droplets onto the catalyst itself.

Table 1: JM support and hold-down media

	High purity alumina	Alumina silicate
Support balls	KATALCO 92-1	KATALCO 92-2
High voidage media	DYPOR 607	DYPOR 604

Table 2: Support media applicability to reactors

Duty	Alumino silicate	High purity alumina	KATALCO 94-1ZT
HDS	✓	✓	
ZnO	✓	✓	
Pre-reformer		✓	
Secondary/ATR		✓	✓
HTS		✓	
LTS	✓	✓	
Methanation	✓	✓	
Methanol synthesis	✓	✓	

Note: KATALCO 94-1ZT is a specialised zirconia based inert for the aggressive conditions encountered in some ATR/secondary reformers.

Fig. 8: Examples of alumina target tile erosion after service



PHOTO: JM

Fig. 9: Condition of KATALCO 94-1ZT target tile after service

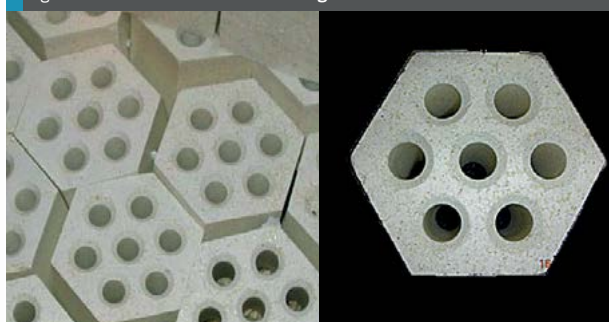

PHOTO: JM

Although aluminosilicate products are cheaper than the equivalent high purity alumina products, silica can leach out under certain operating conditions, which makes it unsuitable for some duties.

Table 2 shows support media applicability to different reactors.

Zirconia tiles – KATALCO 94-1ZTR

ATRs can suffer from the degradation of hold-down media even if high purity alumina is used. The problem is more prevalent in oxygen than in air fired reformers due to higher top of bed temperatures and

can increase in severity if the unit is operating above its original design rate or is suffering from burner design issues.

At high temperatures the alumina reacts with steam and forms aluminium hydroxide vapour.

As the temperature falls due to the endothermic steam reforming reaction it reverts back to solid Al₂O₃ and deposits on surfaces.

Deposition of the alumina within a catalyst bed can lead to:

- a loss of activity due to active sites being inaccessible due to alumina deposits;
- agglomeration of the catalyst pellets which can cause maldistribution of process gas and an increase in methane slip;
- an increase in pressure drop due to flow restrictions.

Material may also deposit in downstream units such as the process gas boiler and the water gas shift beds. Examples of the effect of poor stability and erosion of standard alumina target tiles is shown in Fig. 8.

A decade ago, JM pioneered the development of stabilised zirconia target tiles, KATALCO 94-1ZT to solve this problem.

As zirconia has a higher melting point and a lower vapour pressure than alumina, it is much more stable and therefore much more resistant to vaporisation and consequent loss of material.

The first application of KATALCO 94-1ZT tiles was over ten years ago and Fig. 9 shows images of the 'as new' condition of KATALCO 94-1ZT after this long term service in an oxygen-fired ATR.

STREAMLINE pressure drop reduction

JM developed STREAMLINE, a value adding pressure drop reduction system, to replace conventional ceramic ball support media.

The STREAMLINE system combines computational modelling expertise with high voidage DYPOR media to reduce pressure drop.

STREAMLINE was originally developed in response to a number of high temperature (HT) and low temperature (LT) shift reactors exhibiting high pressure drops.

On investigation it was discovered that a high portion of the vessel pressure drop was associated with the area around the collector, this was confirmed by detailed

Fig. 10: STREAMLINE flow modelling of shift reactor



Source: JM

computational flow modelling (Fig. 10).

The specific size grades of DYPOR to be used as a support media vary depending on the vessel configuration and particle size of material being supported. JM have a proprietary STREAMLINE software program which is configured for a full range of vessel collector designs.

Fig. 11 shows a STREAMLINE model of a vessel with a dished bottom collector, along with plant data showing the 60% reduction in pressure drop that resulted from the deployment of STREAMLINE on this particular vessel.

Fig. 11: Case study STREAMLINE flow simulation and results

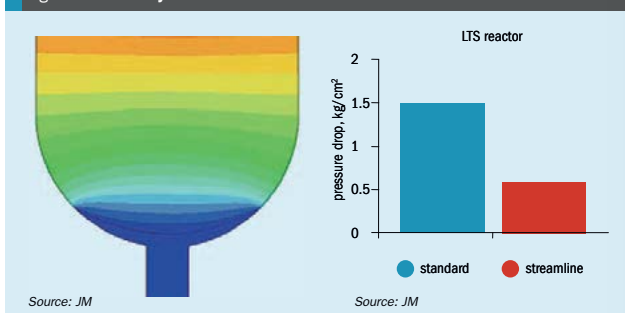

Source: JM

Source: JM

PURASPEC 2272 - Cl-guarding support media

JM has used its expertise in purification science along with its proven STREAMLINE engineering skills to develop PURASPEC 2272 – an innovative patented new product which combines the functions of a low pressure drop support with that of a chloride trap (Fig. 12).

The LTS is both the most expensive catalyst in the front end of an ammonia plant and one of the most critical in terms of plant performance. LTS catalysts do

however have a well-known sensitivity to chloride which acts as a virulent poison.

PURASPEC 2272 is a solution which provides protection by helping to stop chlorides from reaching the LTS catalyst. Chlorides are very soluble and so are mobile when wetted. This means that condensation on a LTS catalyst can distribute chlorides throughout the bed and have a severe impact on catalyst performance.

In Fig. 13 the location for PURASPEC 2272, at the bottom of the HTS vessel (A), gives a much greater safety margin against dewpoint compared to traditional location

Fig. 12: Application of PURASPEC 2272 in HTS

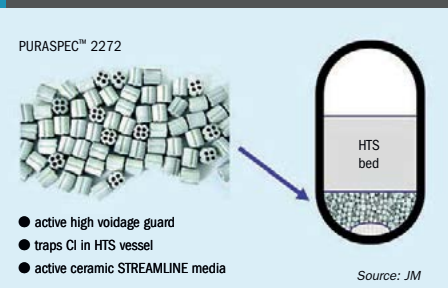

Source: JM

Fig. 14: Extended life of LTS from use of PURASPEC 2272

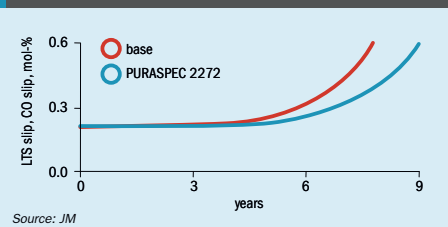

Source: JM

Fig. 13: Possible locations for a Cl-guard in the shift section

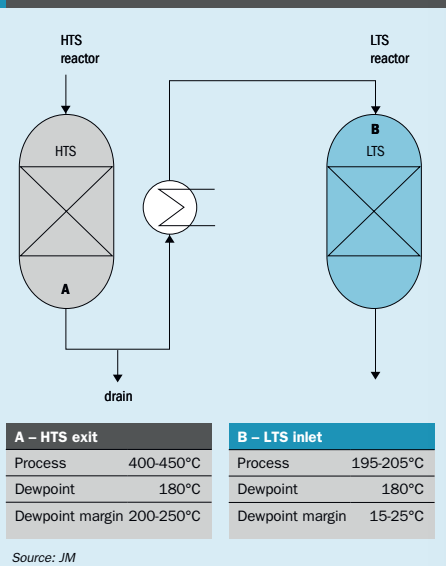

Source: JM

for a dedicated Cl-guard on top of the LTS bed (B).

The use of PURASPEC 2272 at a location below the HTS gives a number of benefits:

- dewpoint margin is above 200°C;
- chlorides are kept out of LTS reactor;
- should wetting occur, chlorides can leave from a drain rather than enter LTS.

The first reference for the technology is a large ammonia plant, operating at 120% of design capacity, which sought to extend LTS life by reducing the rate at which the LTS was being poisoned. The anticipated LTS life extension from using PURASPEC 2272 is shown in Fig. 14.

Topsoe HTZR™ target tiles and catalyst bed support

Topsoe's advanced solutions for ATR and oxygen-blown secondary reforming include special Topsoe-developed zirconia-based HTZR™ target tiles with outstanding chemical and wear stability and an improved catalyst support system providing a robust and high-strength design.

HTZR™ target tiles

In the Topsoe ATRs and oxygen-blown secondary reformers, the combustion chamber and refractory materials are an integral part of the reactor design. This includes a floor of shaped dense ceramic tiles, which is installed in order to:

- act as the partition between the combustion chamber and the catalyst bed,
- protect the catalyst from any direct impact from the open flame in the combustion chamber,
- hold down the catalyst and keep it in place during operation.

During long-term operation in industrial reformers it has been proven that the material loss from the reformer combustion chamber can be lowered significantly by use of Topsoe HTZR™ target tiles made of zirconia material.

The main advantages of operating with Topsoe HTZR™ tiles are:

- Increased lifetime of the tile floor
- Reduced rate of degradation and wear of the individual tiles
- Reduced material deposition in the catalyst bed
- Longer runtime between catalyst skimmings with low and permissible levels of pressure drop over the catalyst bed.

Fig. 15: Post operation inspection of Topsoe HTZR™ target tiles



PHOTO: TOPSOE

- Reduced risk of any critical disintegration of the tile floor.

The use of HTZR™ target tiles made of this superior material in the combustion chamber is a vital part of the overall solution to limit material deposition in the catalyst bed and pressure drop build-up, ensuring an extended and more stable time of operation in oxygen-blown secondary reformers and ATRs.

Topsoe target tiles have a proven industrial track record. The HTZR™ target tiles have six years of operation in several industrial units, and the performance shows an outstanding chemical stability and wear resistance (Fig. 15).

Catalyst bed support structure

The catalyst bed support serves both as structural support for the catalyst bed and as an outlet flow distributor guiding the syngas from the catalyst bed into the transfer line to the waste heat recovery system downstream the reformer.

Various types of catalyst bed support exist for ATRs and oxygen-blown secondary reformers ranging from pyramid type structures to arch and dome type constructions.

For decades, Topsoe has successfully used the pyramid type bed as catalyst

support, and failures and collapse with this type of support have not been observed. However, some degree of maintenance is generally reported to individual pieces of the ceramic elements.

A new Topsoe catalyst bed support has therefore been developed in order to minimise the customer's operational risk and need of maintenance. The current trend of building increasingly larger ATR reactors, necessitates a catalyst bed support with increased mechanical strength.

Fundamental examination and a thorough understanding of the forces acting on the catalyst bed support and the individual brick shapes has facilitated the new design.

The investigations include forces stemming from:

- weight of catalyst above,
- fluid dynamic pressure drop and
- thermal loads.

The design was made using finite element analysis (FEA) and took into consideration the many acting forces on the full structure and on the individual bricks to locate areas of elevated stress levels on the construction. The new Topsoe catalyst support provides customers with improved reliability.

Advertisers' index

Editor: RICHARD HANDS
richard.hands@bcinsight.com

Technical Editor: LISA CONNOCK
lisa.connock@bcinsight.com

Contributors:
ALISTAIR WALLACE
alistair.wallace@integer-research.com
MIKE NASH
mike.nash@ihs.com

Publishing Director: TINA FIRMAN
tina.firman@bcinsight.com

Subscription rates:
GBP 425; USD 850; EUR 655

Subscription claims:
Claims for non receipt of issues must be made within 3 months of the issue publication date.

Sales/Marketing/Subscriptions:
MARLENE VAZ
Tel: +44 (0)20 7793 2569
Fax: +44 (0)20 7793 2577
marlene.vaz@bcinsight.com
Cheques payable to BCInsight Ltd

Advertising enquiries:
TINA FIRMAN
tina.firman@bcinsight.com
Tel: +44 (0)20 7793 2567

Agents:
Japan: (also subscription enquiries)
KOICHI OGAWA
O.T.O. Research Corporation
Takeuchi Building
1-34-12 Takadanobaba
Shinjuku-Ku, Tokyo 169, Japan
Tel: +81 3 3208 7821
Fax: +81 3 3200 2889

Previous articles from Nitrogen+Syngas and Nitrogen & Methanol from 1996 to the present are available digitally in PDF format. To make a purchase, or for a list of available articles, please see: www.bcinsight.com

Copyright: Issued six times per year, or bi-monthly. All rights reserved. No part of this publication may be reproduced, stored in a retrieval system or transmitted in any form or by any means – electronic, mechanical, photocopying, recording or otherwise – without the prior written permission of the Copyright owner.

ISSN: 1750-6891

Design and production:
JOHN CREEK, DANI HART



Printed in England by:
Buxton Press Ltd
Palace Road, Buxton, Derbyshire,
SK17 6AE

© 2018 – BCInsight Ltd

BCInsight

Published by: BCInsight Ltd
Southbank House, Black Prince Road
London SE1 7SJ, England
Tel: +44 (0)20 7793 2567
Fax: +44 (0)20 7793 2577
Web: www.bcinsight.com
www.bcinsightsearch.com

Advertiser	Page	Website
Air Liquide Global	25	airliquide.com
Aumund	15	aumund.de
Casale	34/35	casale.ch
Casale	29	casale.ch
Eurotecnica Contractors and Engineers	5	eurotecnica.it
Eurotecnica Contractors and Engineers	OBC	eurotecnica.it
Heraeus	9	heraeus.com
IHS Markit	23	ihsmarkit.com/wmc2018
Integer Research	21	integer-research.com
IPCO Germany GmbH	19	ipco.com
Johnson Matthey	IFC	matthey.com/
Neelam Aqua & Speciality Chem (P) Ltd	IBC	neelamaqua.com
Nitrogen + Syngas 2019 Conference	49	crugroup.com/events
Sabin Metal Corporation	13	sabinmetal.com
Schoeller-Bleckmann Nitec GmbH	11	christof-group.at/en/sbn/
thyssenkrupp Industrial Solutions	41	thyssenkrupp.com
Ventilatorenfabrik Oelde GmbH	17	venti-oelde.com

Next issue: November/December 2018

- Waste to syngas
- Demographics and changing nitrogen fertilizer demand
- Latin America's syngas industries
- Gasification based ammonia and methanol plants
- CO₂ removal system upgrades in ammonia plants

Closing date for advertisement space booking is 25 October 2018
For further information and to book advertisement space contact:
Tina Firman, Publishing Director: tina.firman@bcinsight.com
Tel: +44 (0)20 7793 2567 Fax: +44 (0)20 7793 2577



NEELAM AQUA & SPECIALITY CHEM (P) LTD.

701, North Avenue, Road No. 9A, V.K.I. Area, Sikar Road, Jaipur-302013 (INDIA)
Ph. : +91-141-2333718, 2333418 • Fax : +91-141-2331102 • Mobile : +91-9829069545
Email : mkmathur@neelamaqua.com, support@neelamaqua.com
www.neelamaqua.com



- ✓ ANTICAKING AGENT FOR LOW DENSITY AMMONIUM NITRATE
- ✓ ANTICAKING AGENT FOR HIGH DENSITY AMMONIUM NITRATE
- ✓ POROSITY IMPROVER FOR AMMONIUM NITRATE
- ✓ CORROSION INHIBITOR FOR UAN
- ✓ COLOURING AGENT
- ✓ ADDITIVES FOR LIQUID FERTILIZERS
- ✓ COOLING WATER TREATMENT CHEMICALS



CONTENTS

What's in issue 355

COVER FEATURE 1

India's 'methanol economy'

COVER FEATURE 2

Industrial grade ammonium nitrate

COVER FEATURE 3

Technology integration

COVER FEATURE 4

Inert catalyst support

NITROGEN+SYNGAS
ISSUE 355
SEPTEMBER-OCTOBER 2018

BCInsight

Southbank House, Black Prince Road
London SE1 7SJ, England
Tel: +44 (0)20 7793 2567
Fax: +44 (0)20 7793 2577
Web: www.bcinsight.com
www.bcinsightsearch.com

1
2
3
4
5
6
7
8
9
10
11
12
13
14
15
16
17
18
19
20
21
22
23
24
25
26
27
28
29
30
31



Don't forget the next issue of **Nitrogen+Syngas** November/December 2018

Total Zero Pollution technologies.

This is what we do to help preserve the delicate ecosystems built over hundreds of years.

Euromel® Melamine is the only melamine technology that does not generate (therefore does not release into the environment) solid or liquid effluents.

www.euromel.com



CONTENTS

What's in issue 355

COVER FEATURE 1

India's 'methanol economy'

COVER FEATURE 2

Industrial grade ammonium nitrate

COVER FEATURE 3

Technology integration

COVER FEATURE 4

Inert catalyst support

NITROGEN+SYNGAS
ISSUE 355
SEPTEMBER-OCTOBER 2018

BCInsight

Southbank House, Black Prince Road
London SE1 7SJ, England
Tel: +44 (0)20 7793 2567
Fax: +44 (0)20 7793 2577
Web: www.bcinsight.com
www.bcinsightsearch.com